



Part 2:

BMW 3 Series (F30, F31, F34) 03/2014- (without PDC cut off function)

BMW 4 Series (F32, F36) 09/2013- (without PDC cut off function)

BMW 4 Series (F33) 01/2014- (without PDC cut off function)

BMW 5 Series GT (F07) 01/2014-

BMW 6 Series (F06, F13) 03/2015-

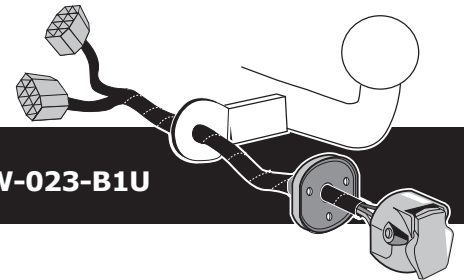

Partnr.: BW-023-B1U

- Fitting instructions electric wiring kit tow bar with 12-N socket up to DIN/ISO Norm 1724.
- We would expressly point out that assembly not carried out properly by a competent installer will result in cancellation of any right to damage compensation, in particular those arising by virtue of the product liability act.
- Contents of these kits and their fitting manuals are subject to alteration without notice, please ensure that these instructions are read and fully understood before commencing installation.
- Do not overload circuits; the maximum loads per connection are detailed in this manual.
- Attention! Before Installation, please read this manual carefully and inform your customer to consult the vehicle owners manual to check for any vehicle modifications required before towing.
- In the event of functional problems, troubleshooting must be limited to about 0.5 hours, contact the technical support:
ukts@ecs-electronics.com / 07440 202 052.



Part list

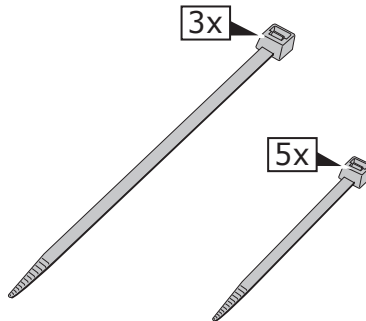
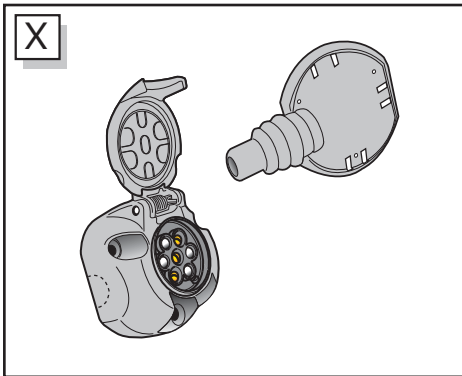
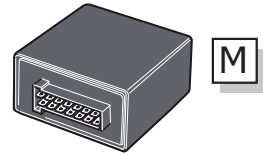
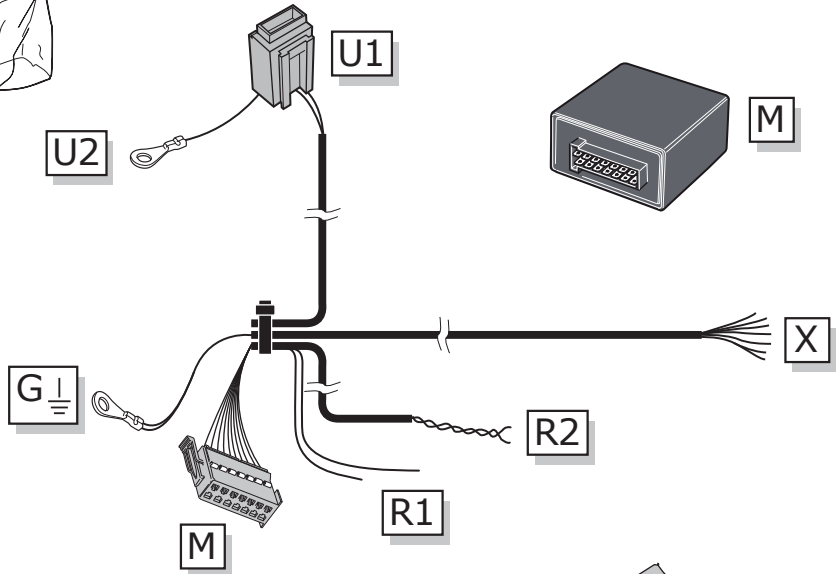
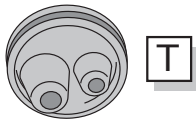
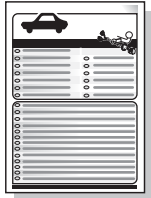
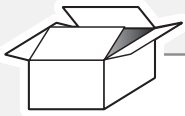

UN-243-YZ
 Optional reverse lamp
 pre-wire extension included

Pag. 31

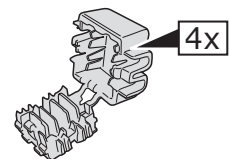
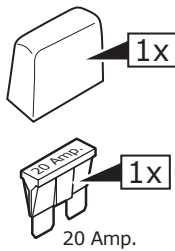
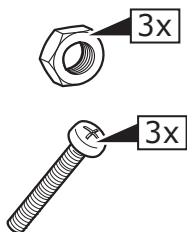

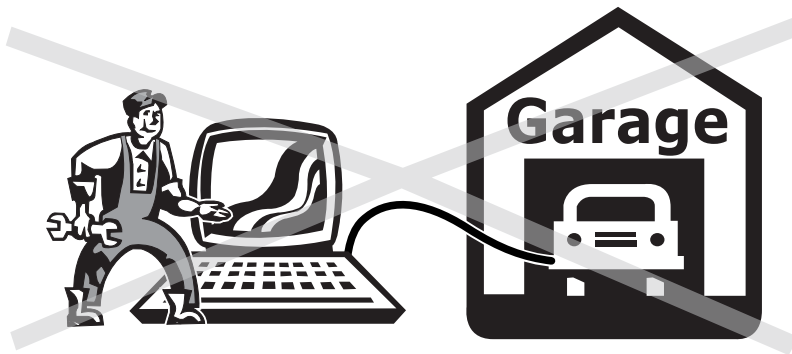

**BMW 3 Series
(F30, F31, F34)
03/2014-**

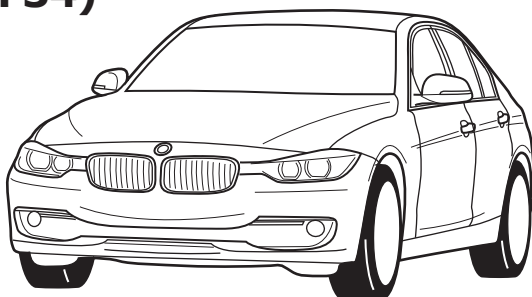

Pag. 5 - 8
+
Pag. 29 - 30

**BMW 4 Series
(Grand) Coupé
(F32, F36)
03/2014-**

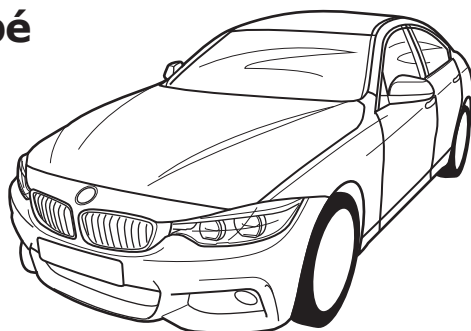

Pag. 9 - 12
+
Pag. 29 - 30

**BMW 4 Series
Cabrio
(F33)
03/2014-**

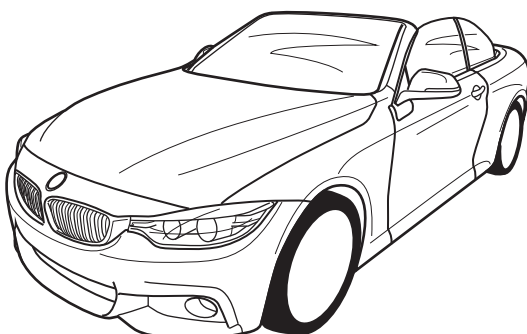

Pag. 13 - 17
+
Pag. 29 - 30

**BMW 5 Series GT
(F07)
01/2014-**

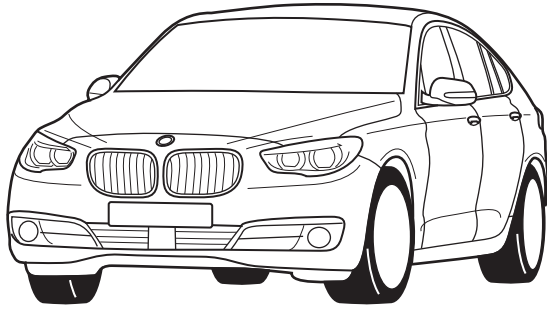

Pag. 18 - 22
+
Pag. 29 - 30

**BMW 6 Series
(Grand) Coupé
(F06, F13)
03/2015-**

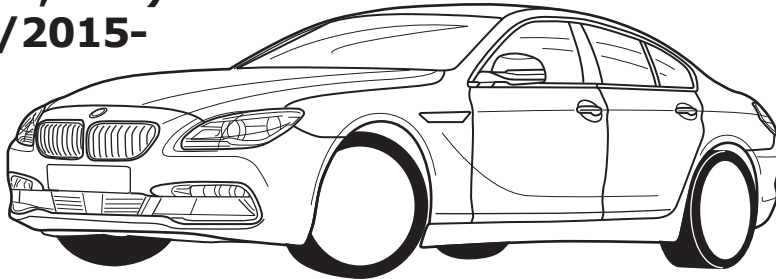

Pag. 24 - 30

INFO

**BMW 3 Series
(F30, F31, F34)
03/2014-**

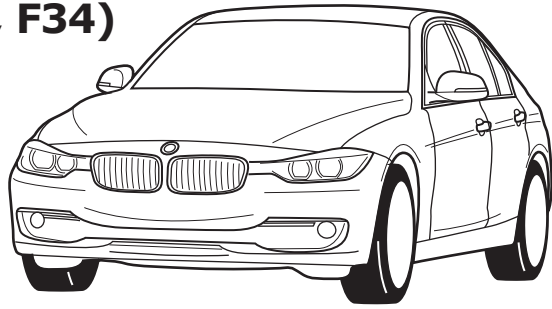

Pag. 5 - 8
+
Pag. 29 - 30

ROUTING

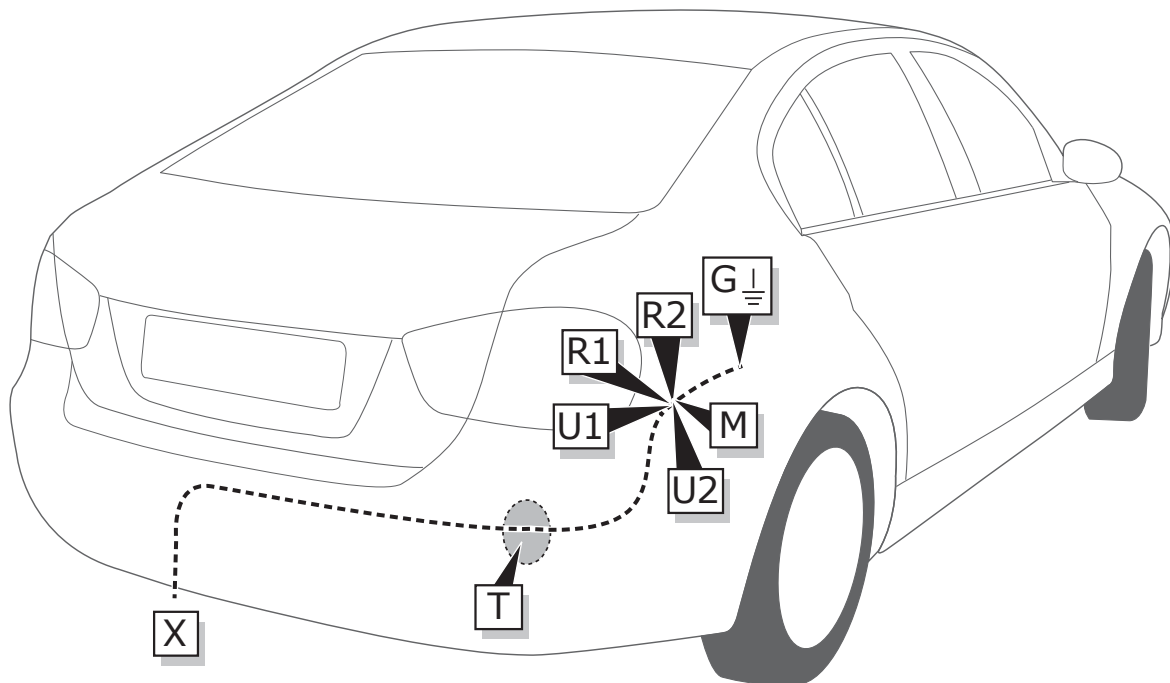

1

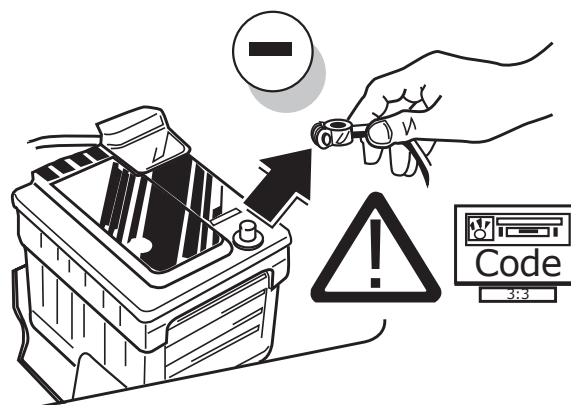
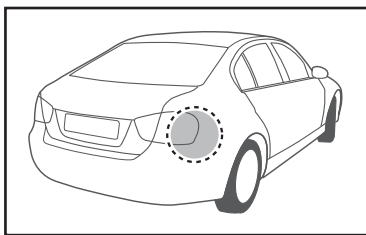

2

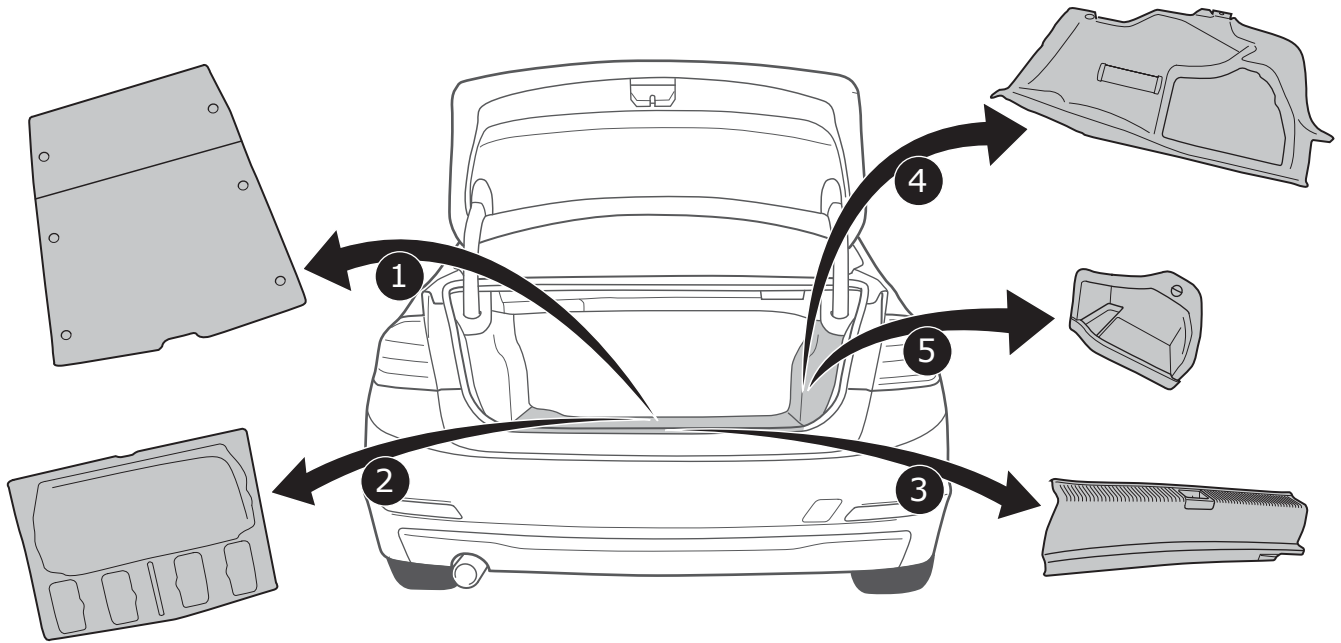

3

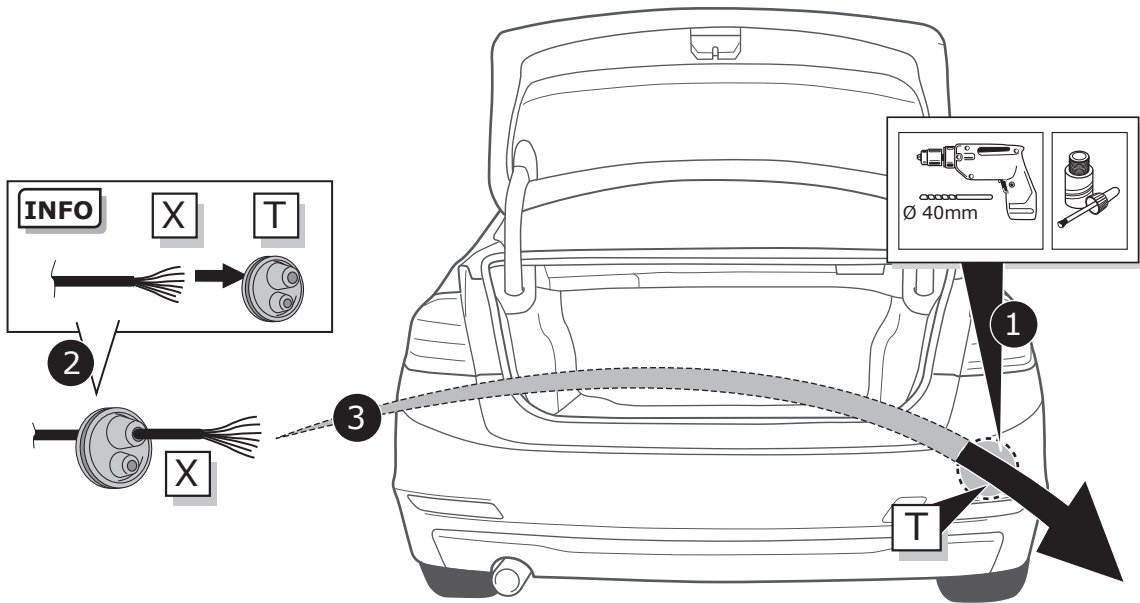

INFO

SOCKET CONNECTION



Pag. 30

4

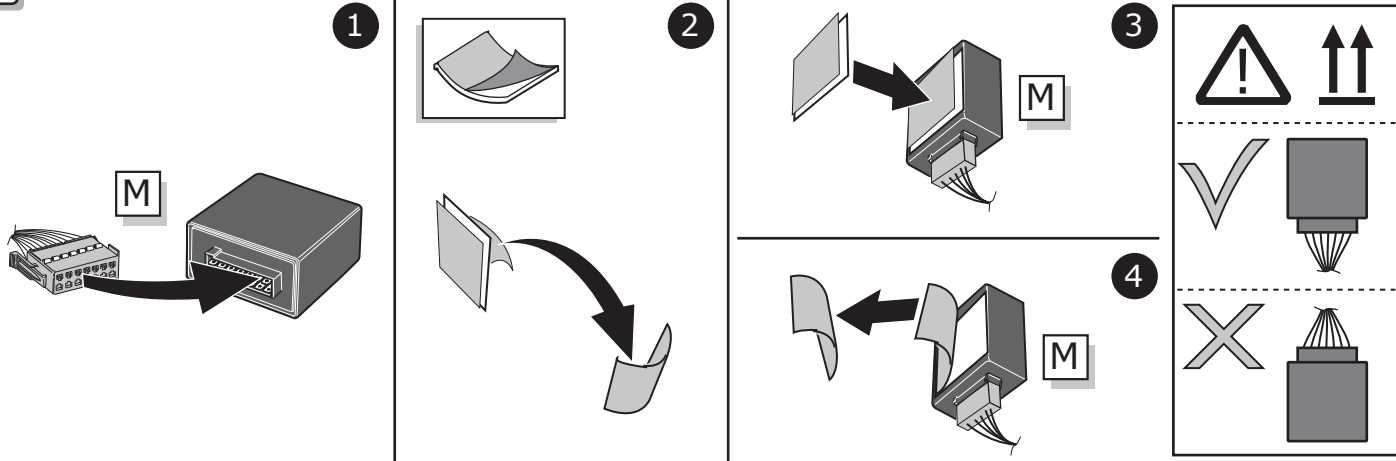

5

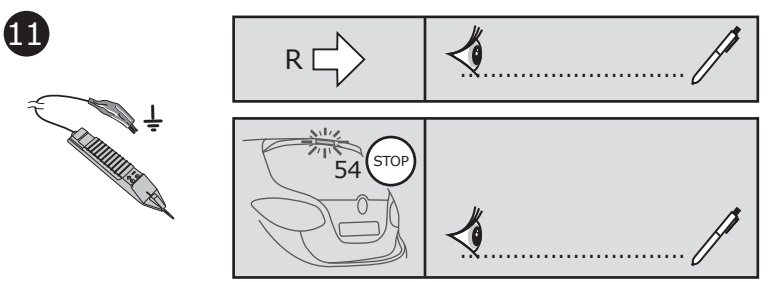
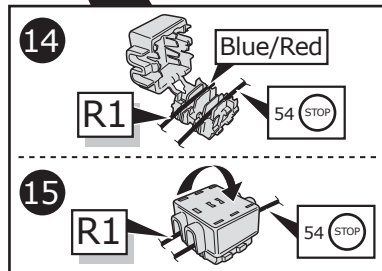
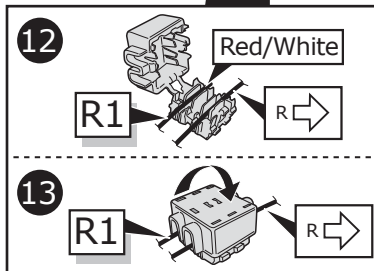
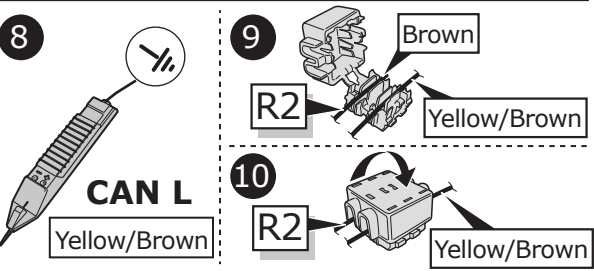
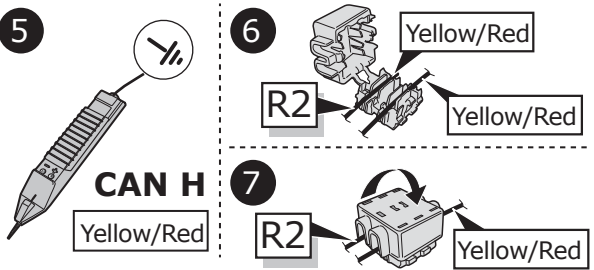
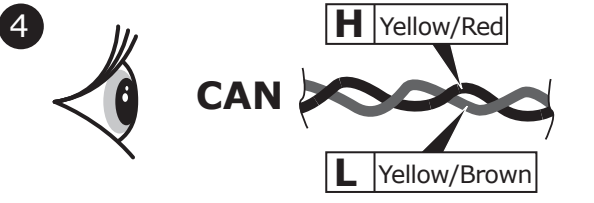
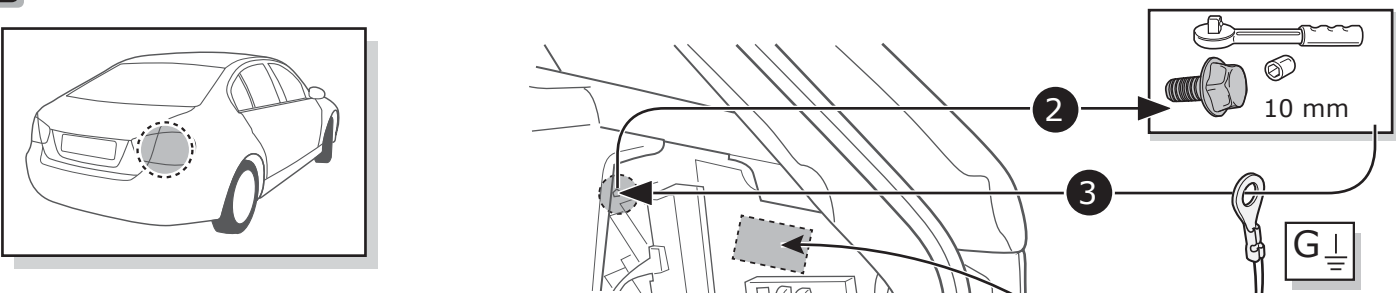

6

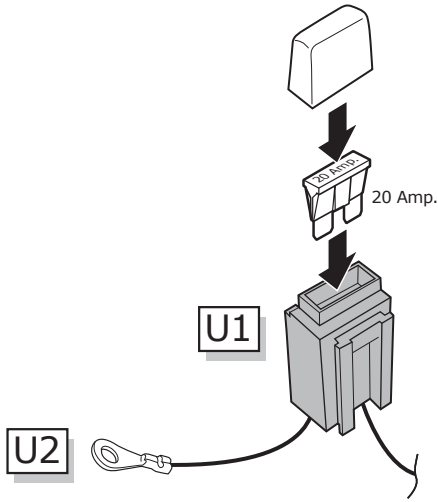
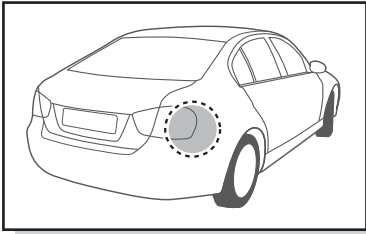

7

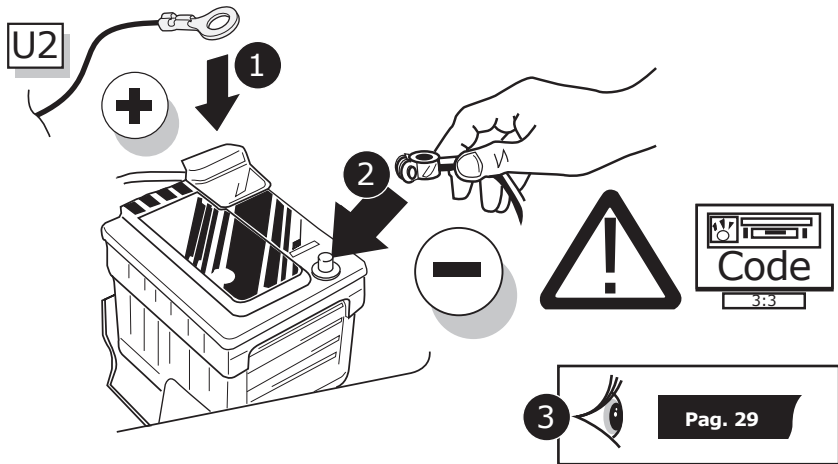
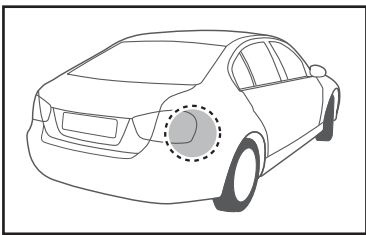

INFO

**BMW 4 Series
(Grand) Coupé
(F32, F36)
03/2014-**

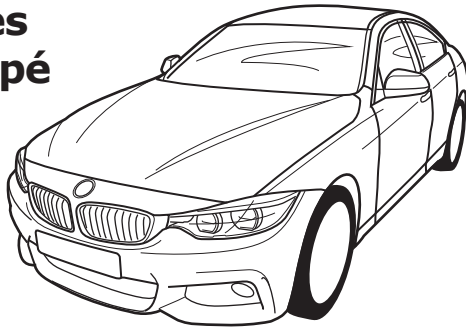

Pag. 9 - 12
+
Pag. 29 - 30

ROUTING

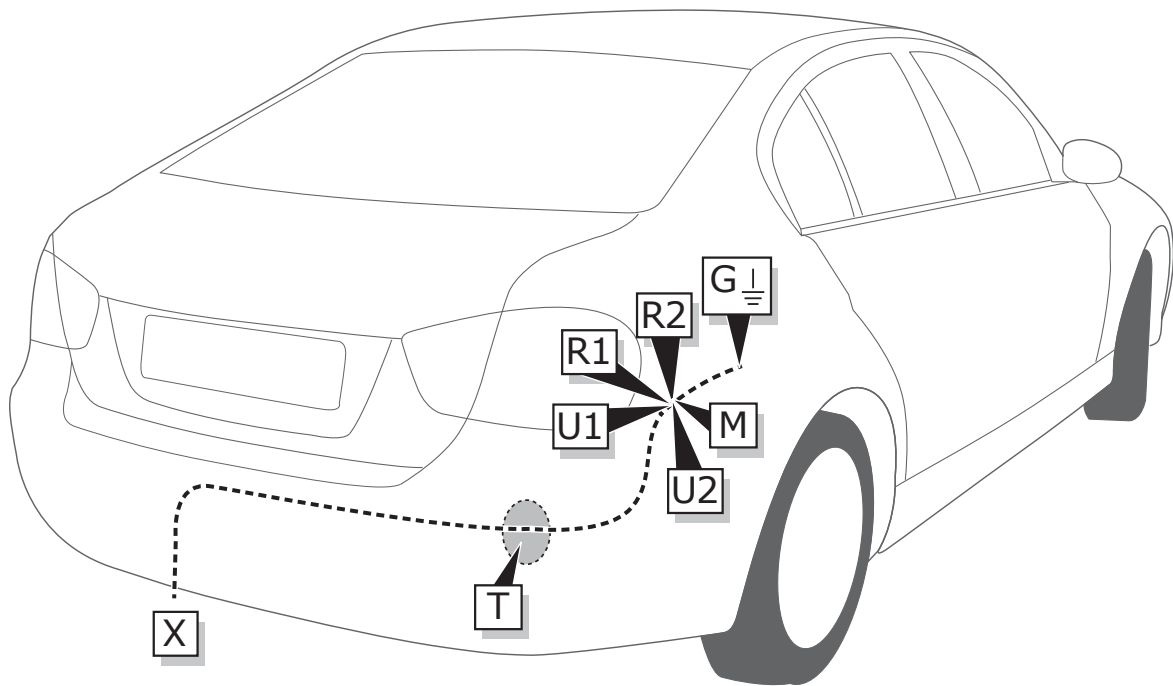

1

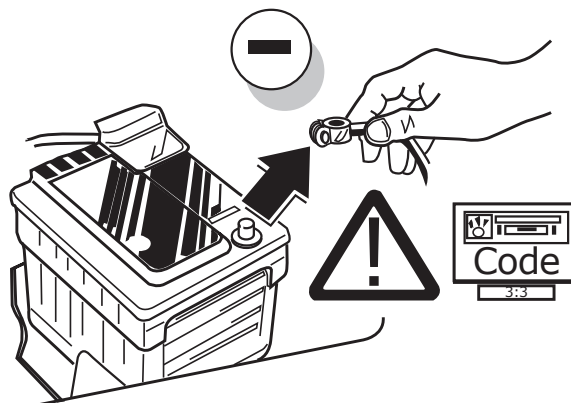

2

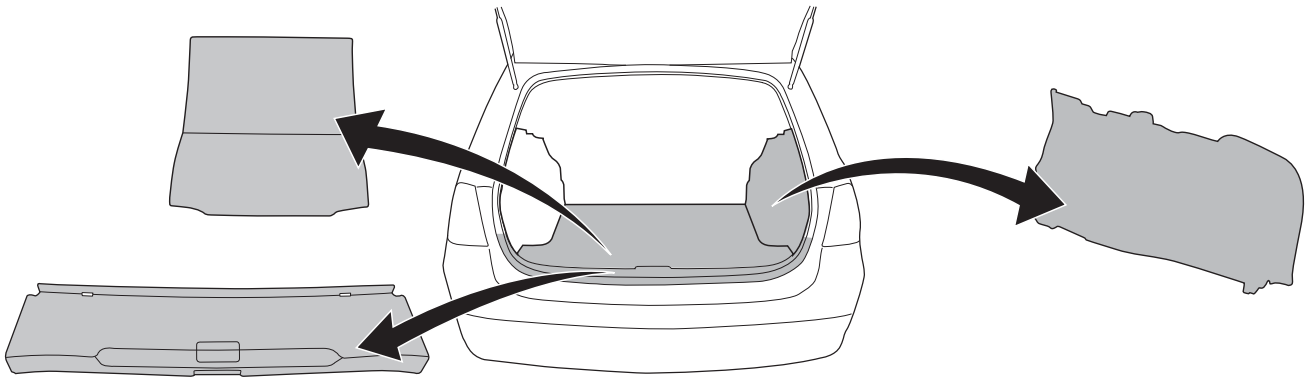

3

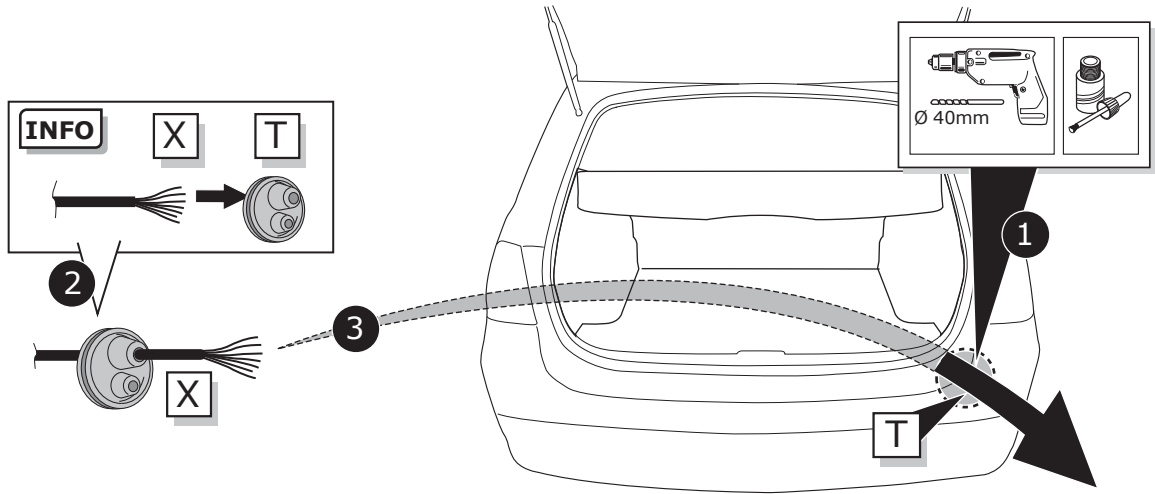

INFO

SOCKET CONNECTION 

Pag. 30

4

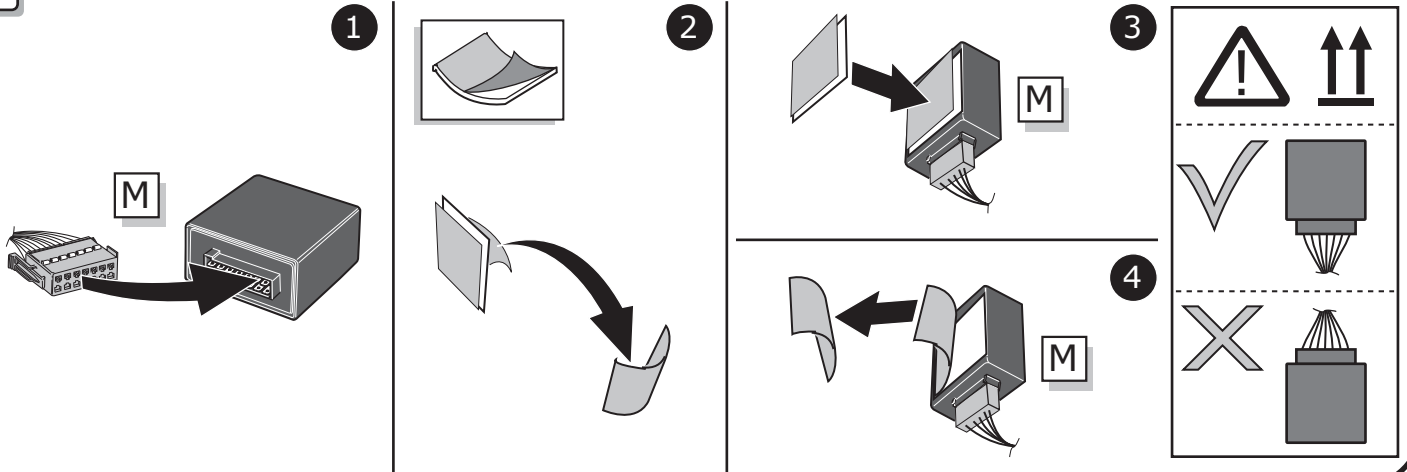

5

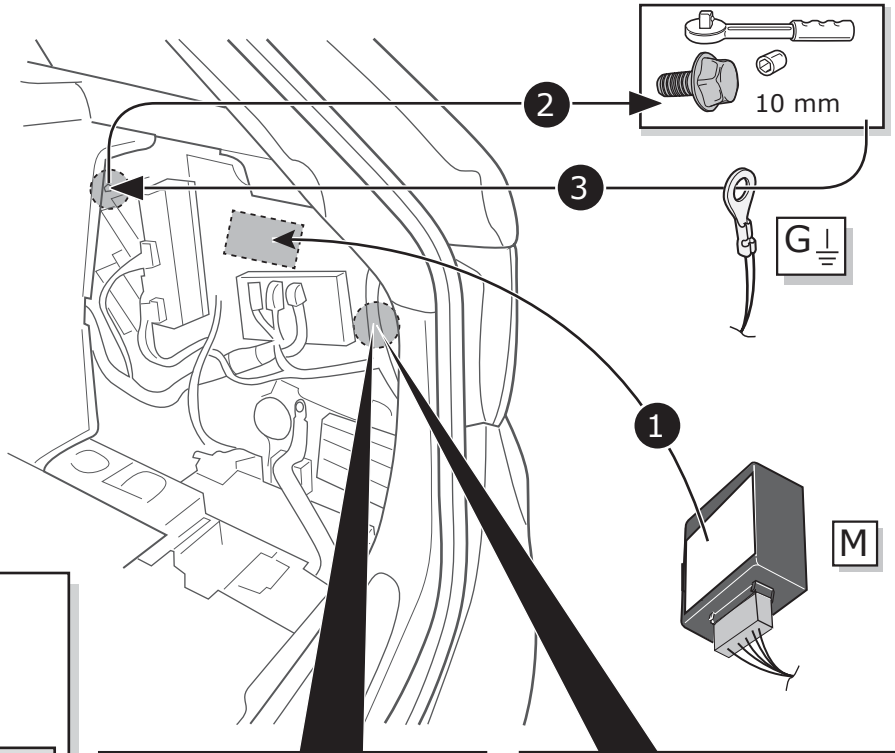
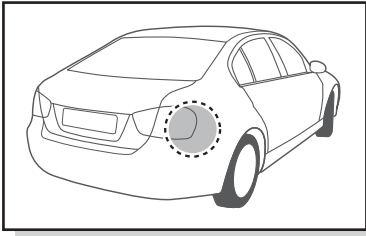

4

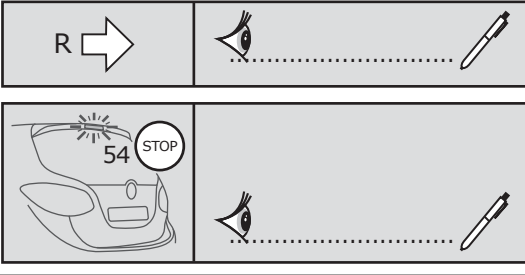
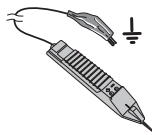

5

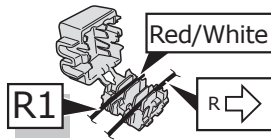

6

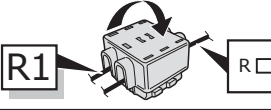

7

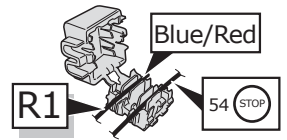

8

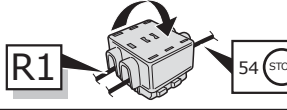

6

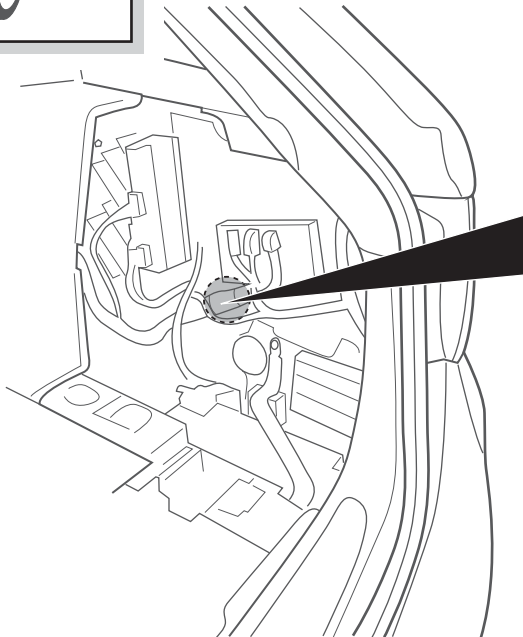
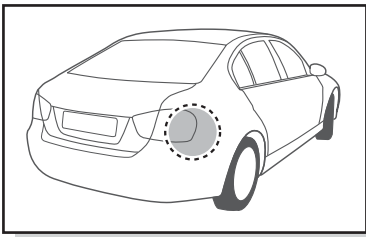

1



2

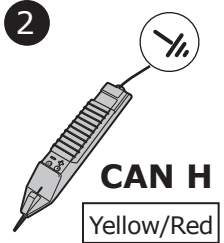

3

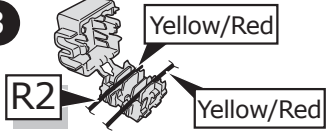

4

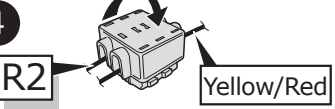

5

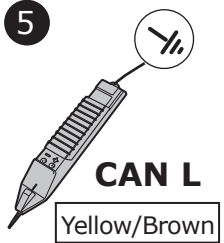

6

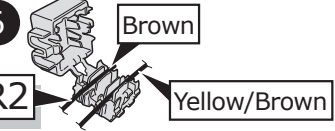

7

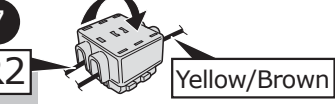

7

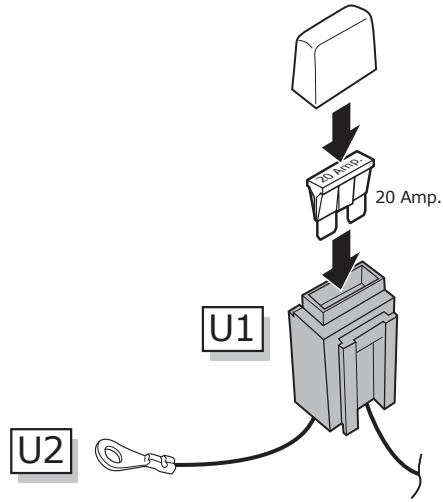
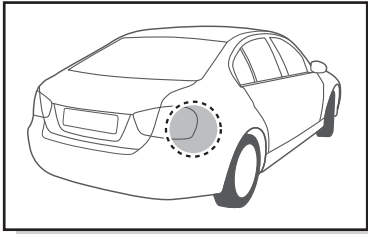

8

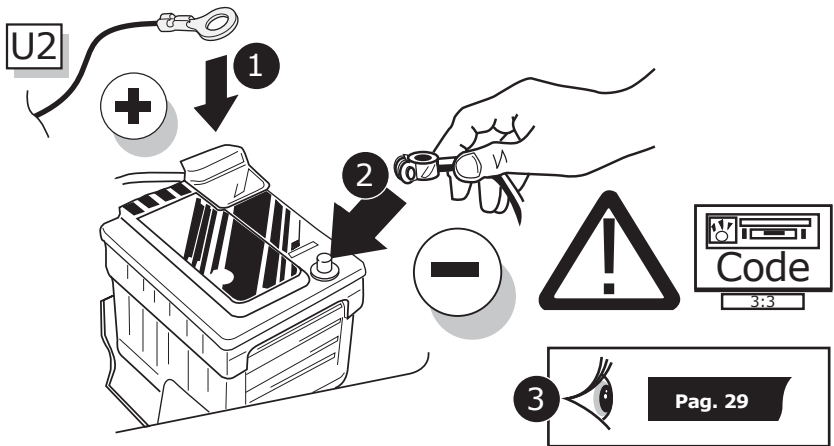
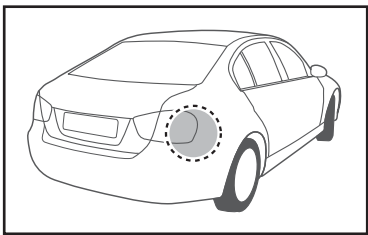

INFO

**BMW 4 Series
Cabrio
(F33)
03/2014-**

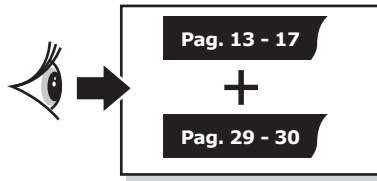
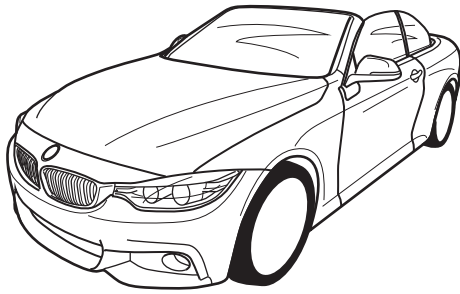

ROUTING

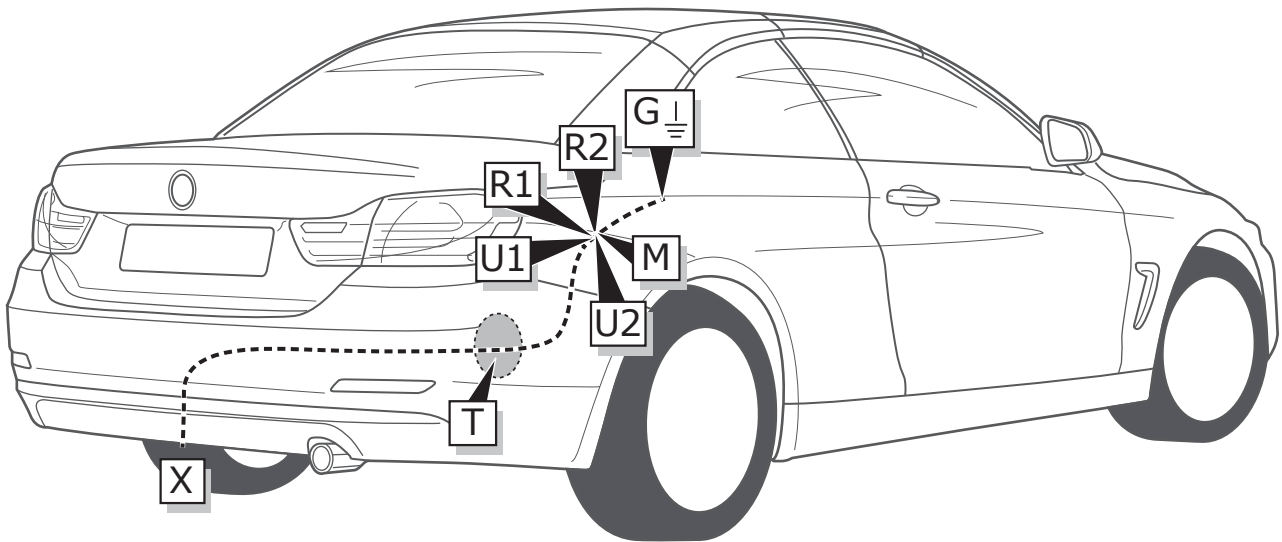

1

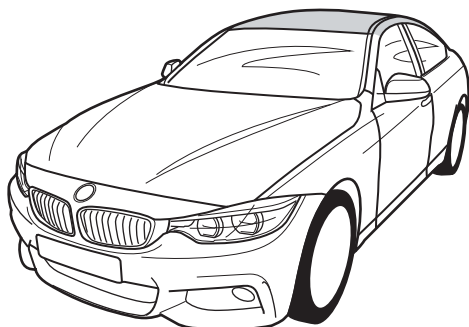
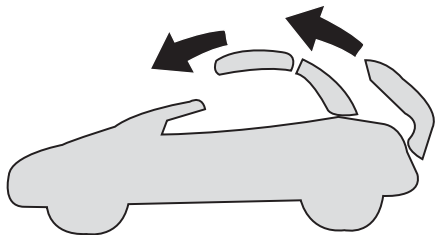

2

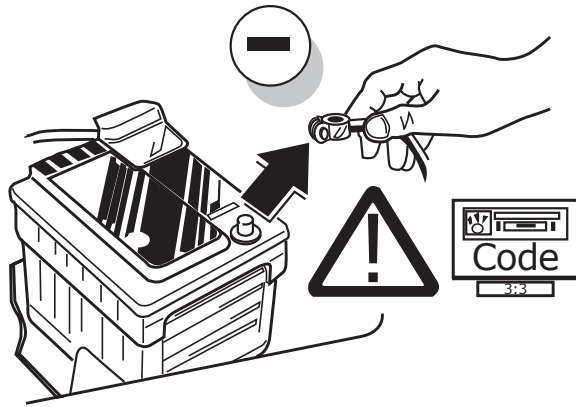

3

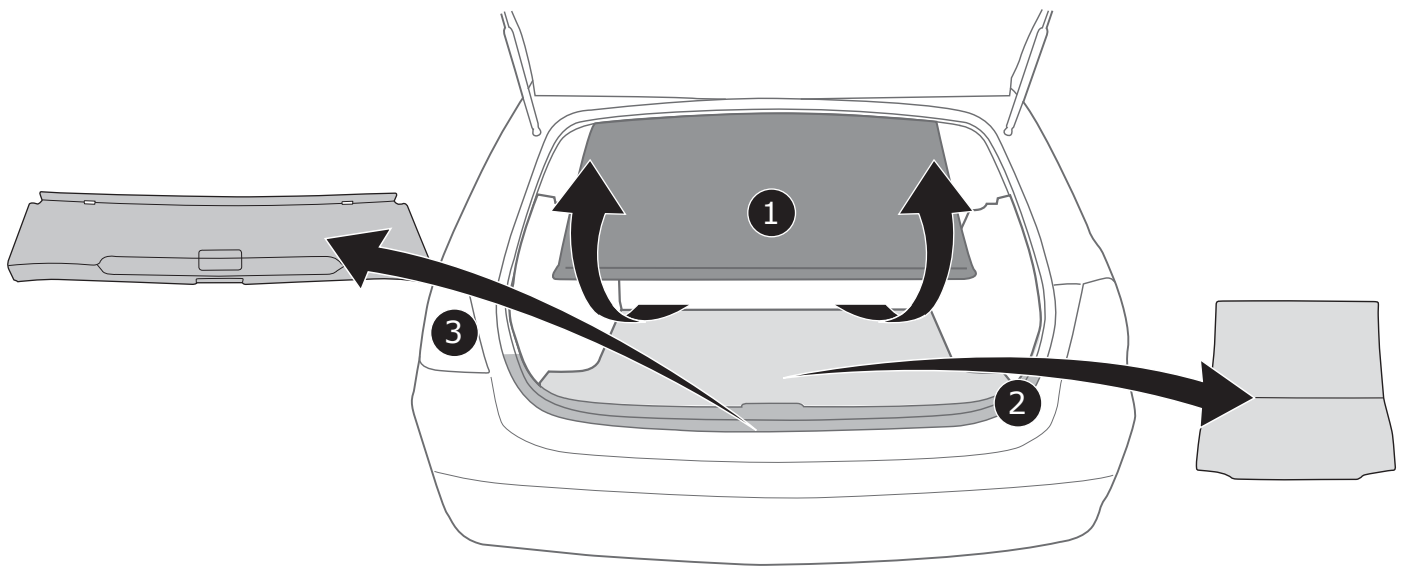

4

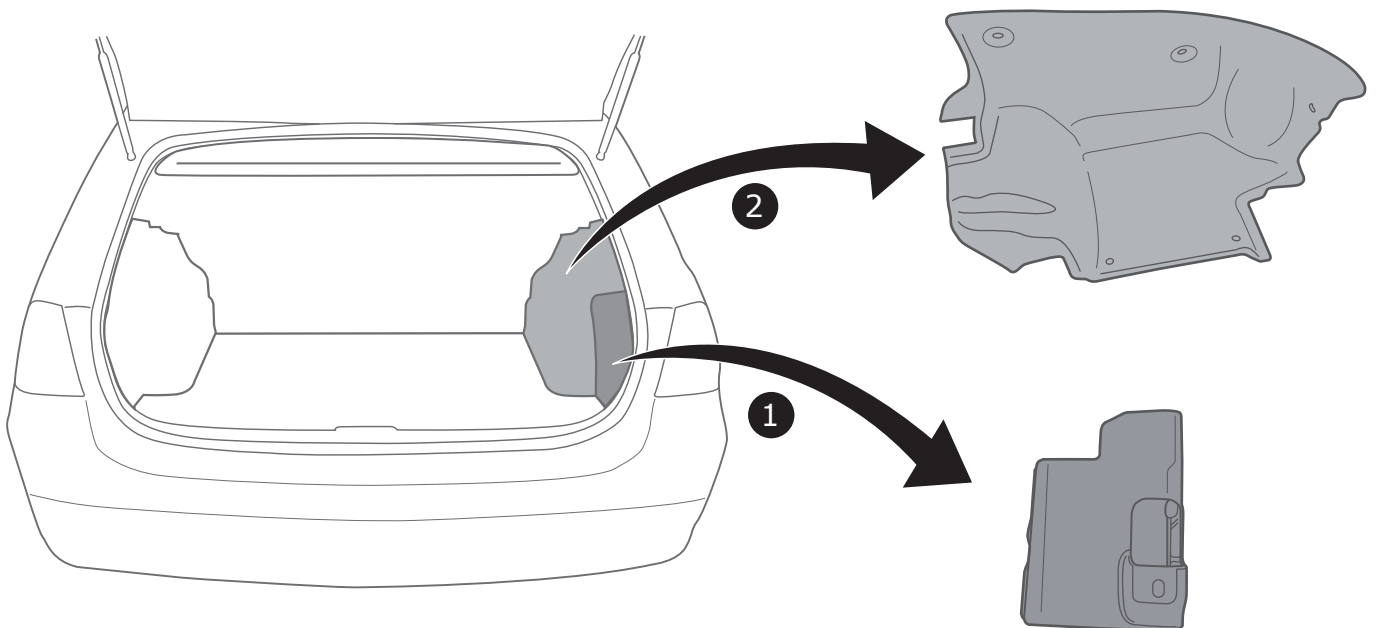

5

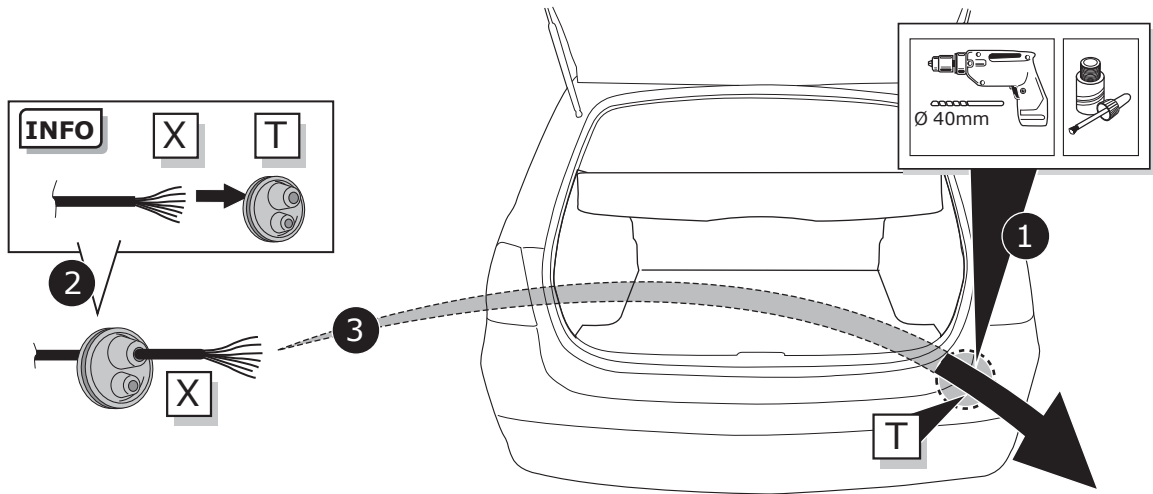

INFO

SOCKET CONNECTION 

Pag. 30

6

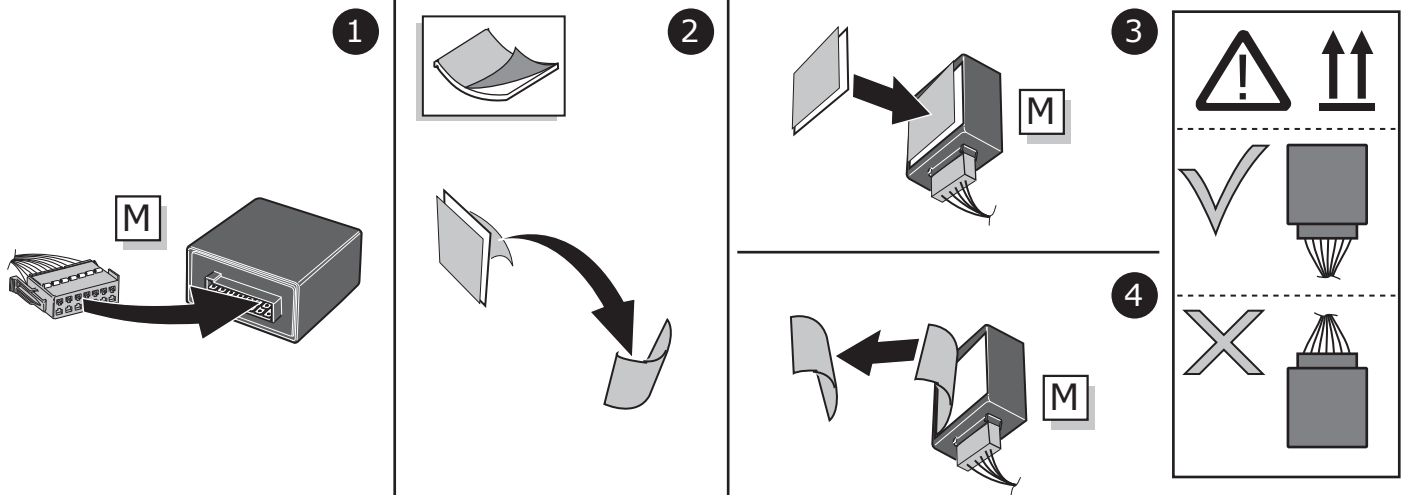

7

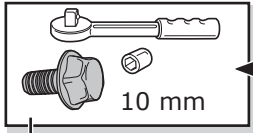

G

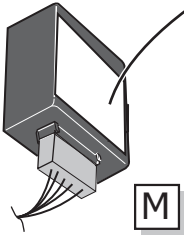

- 2
- 3
- 1

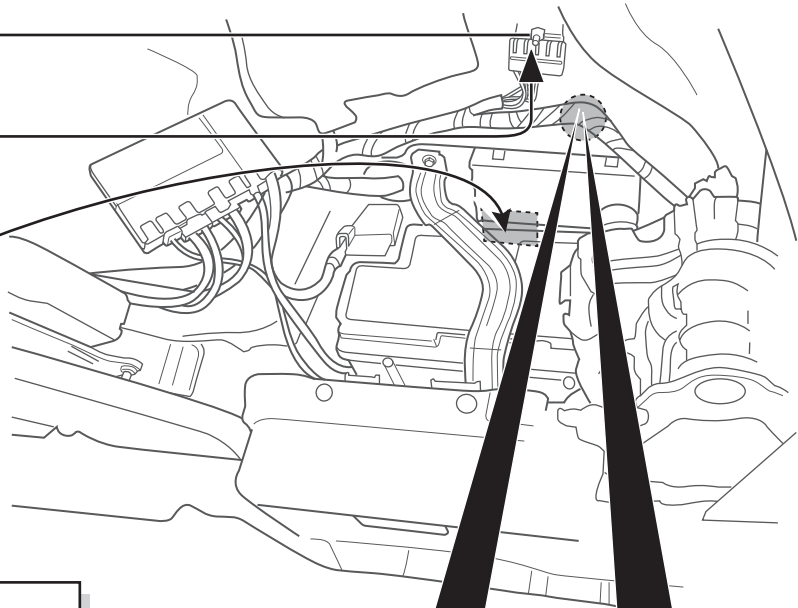

4

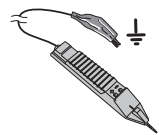

R →	

5

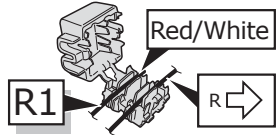

6

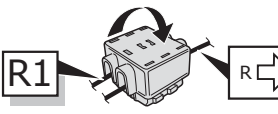

7

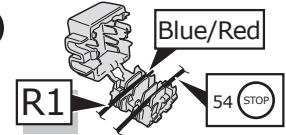

8

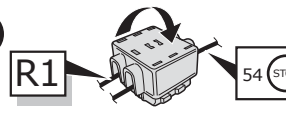

8

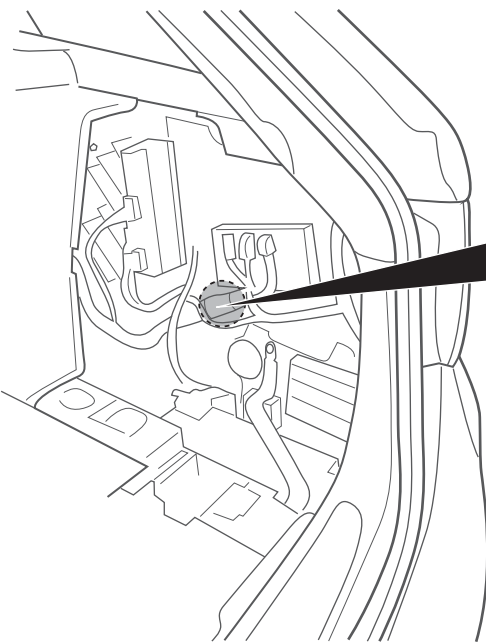

1

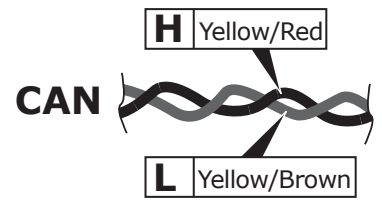

2



3

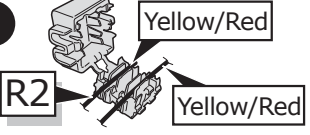

4

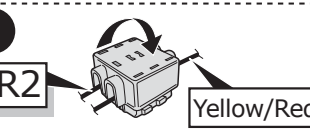

5



6

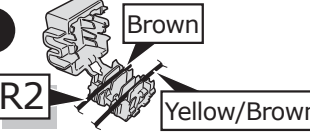

7

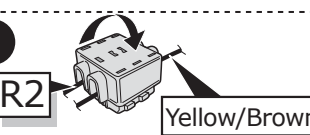

9

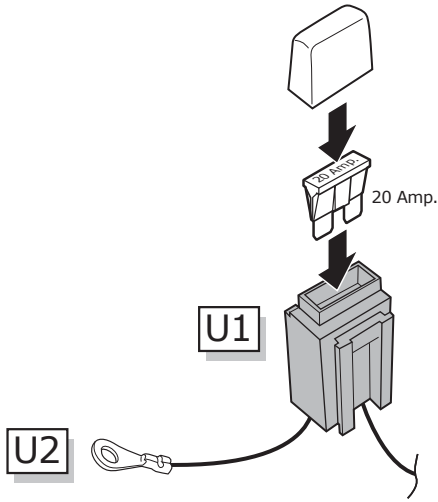
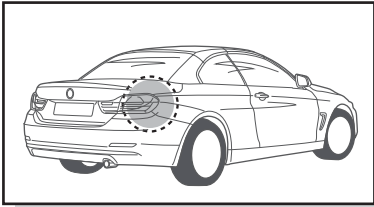

10

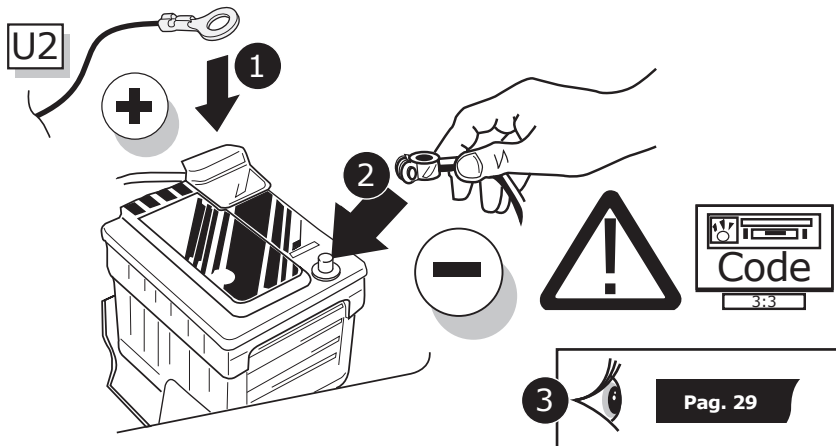
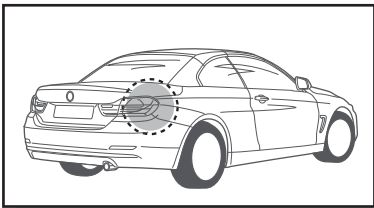

INFO

**BMW 5 Series GT
(F07)
01/2014-**

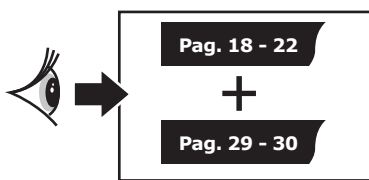
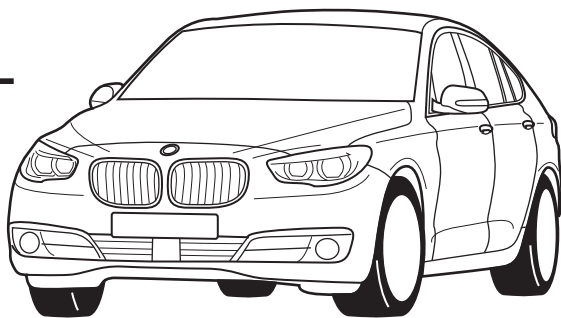

ROUTING

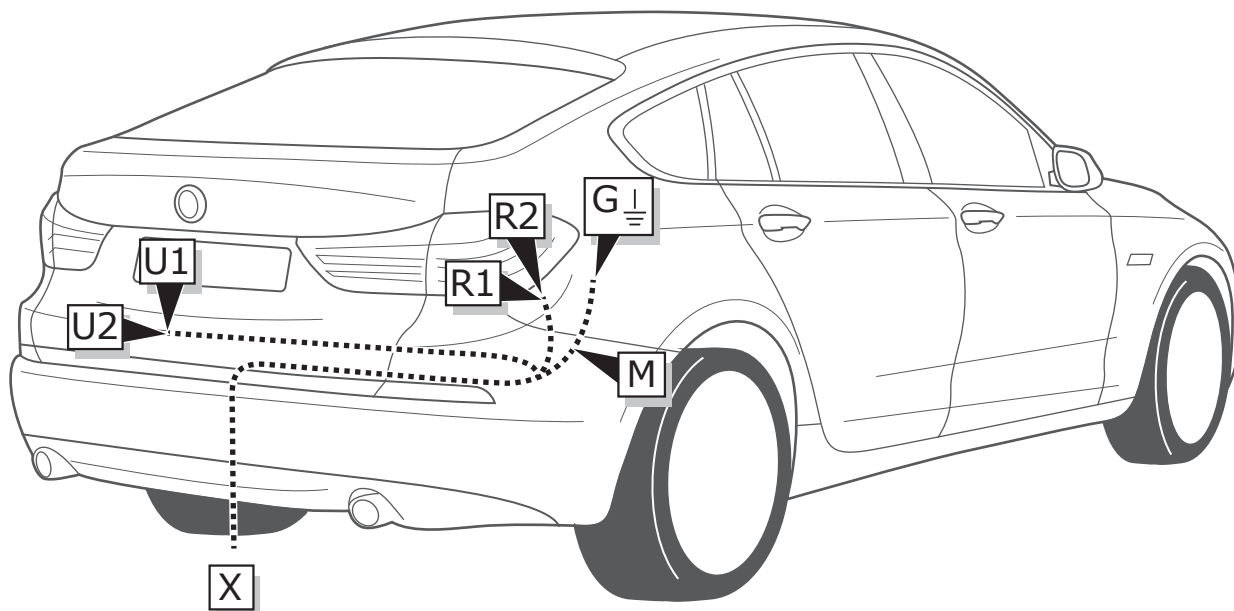

1

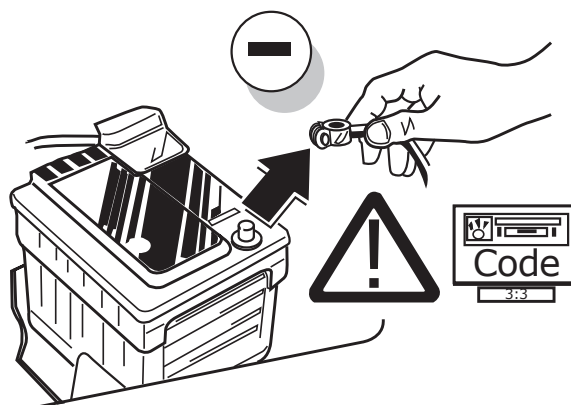

2

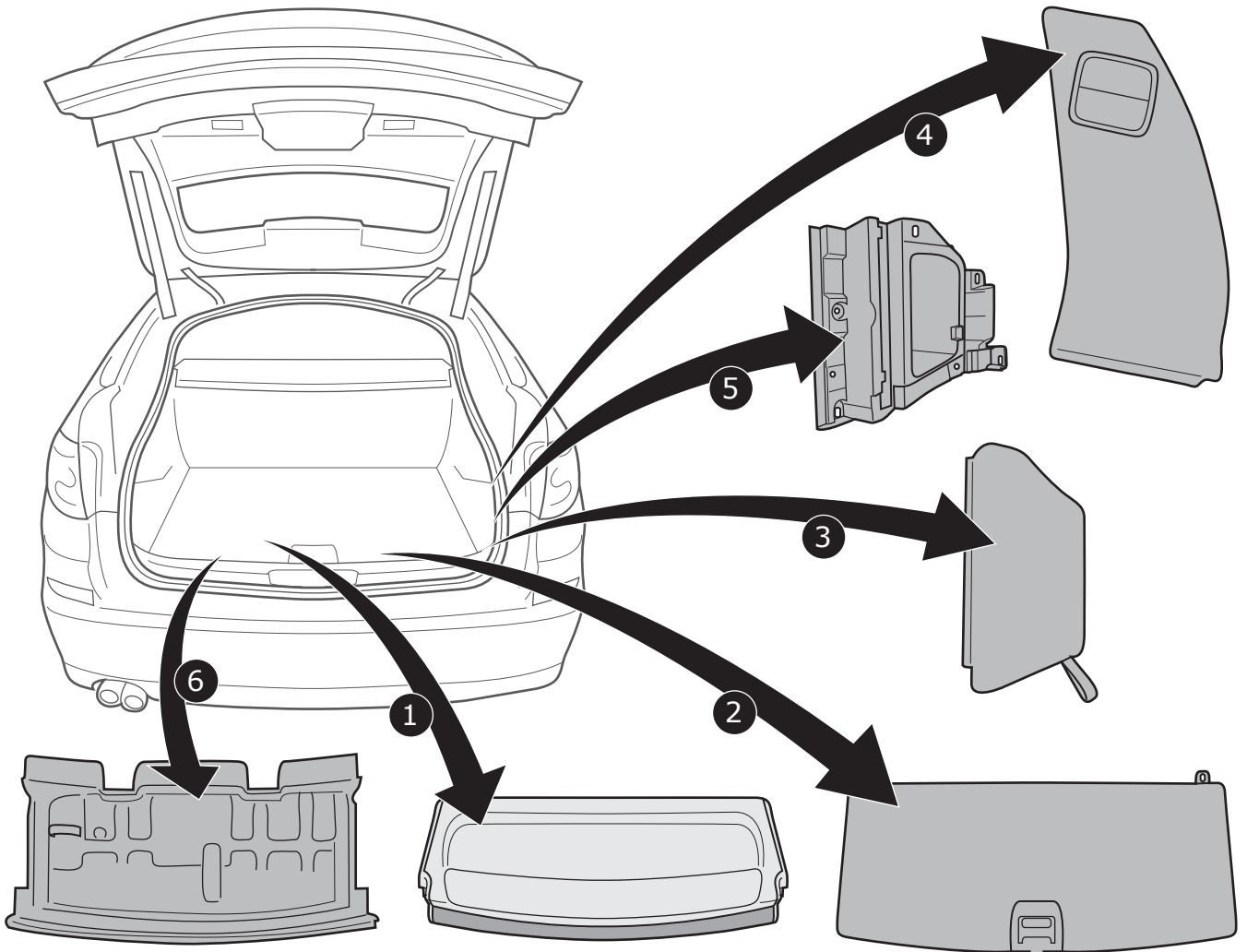

3

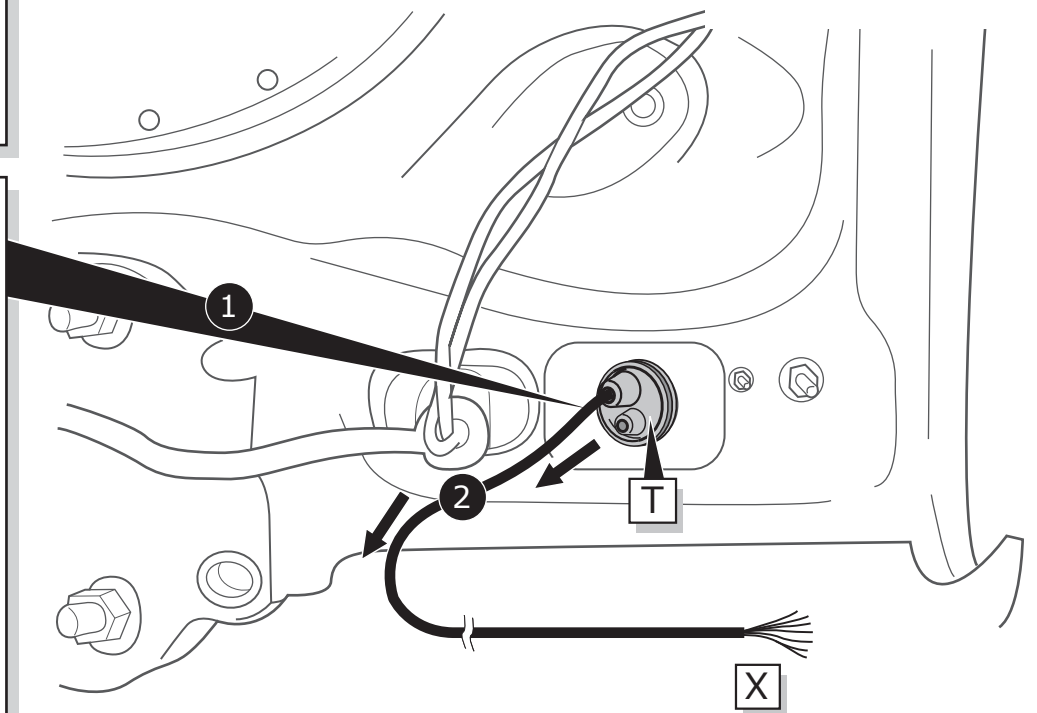
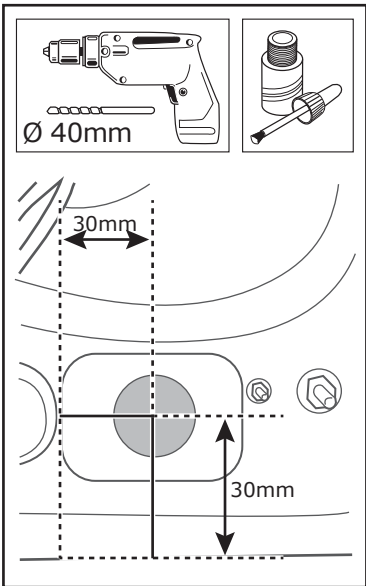
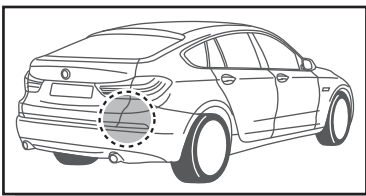

SOCKET CONNECTION

4

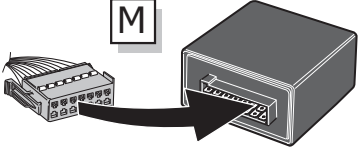
1 

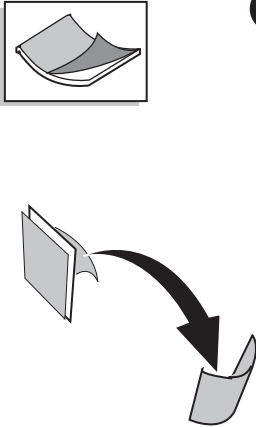
2 

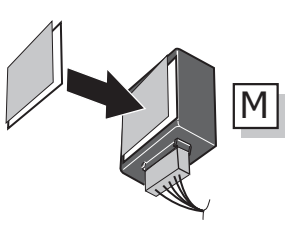
3 

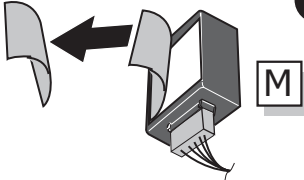
4 



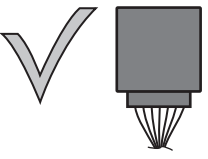

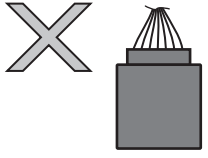

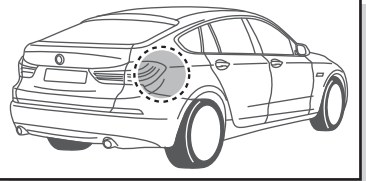

5

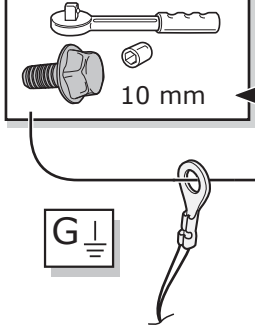

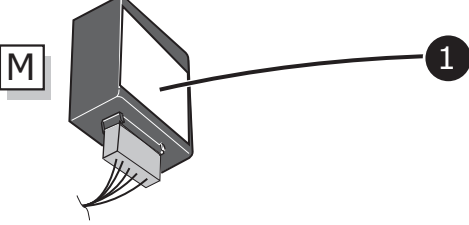

1 

2 

3 



6

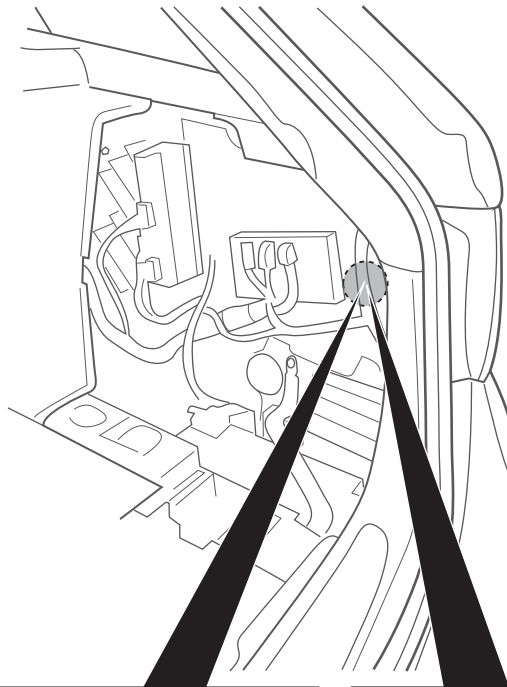
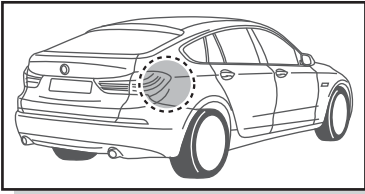

1

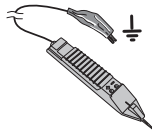

R →

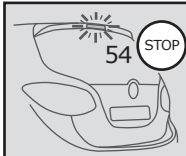
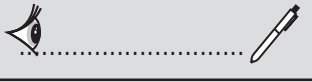

2

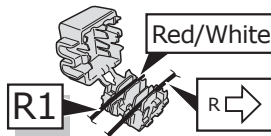

4

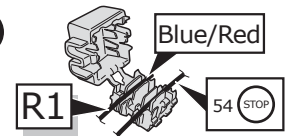

3

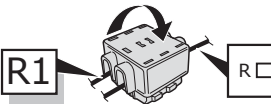

5

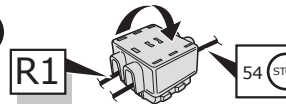

7

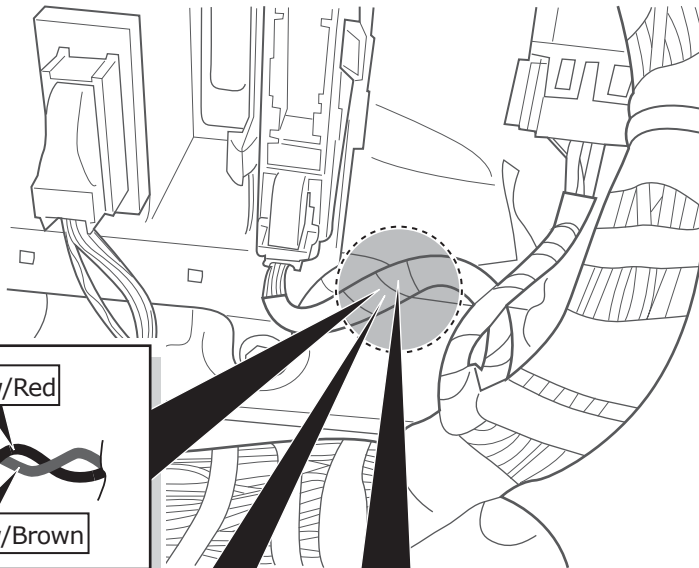
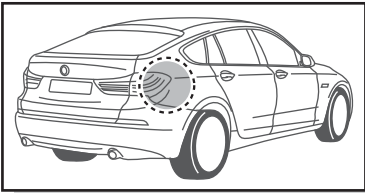

1



CAN

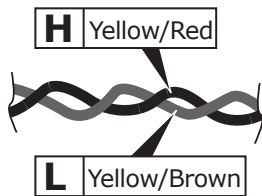

2

CAN H
Yellow/Red

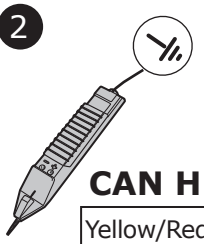

3

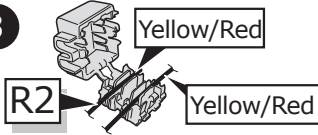

4

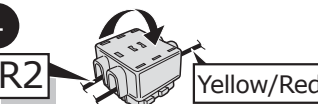

5

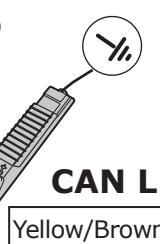

CAN L
Yellow/Brown

6

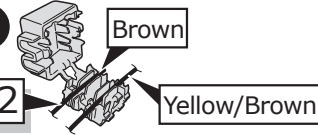

7

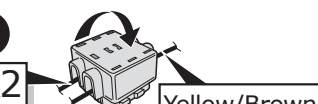

8

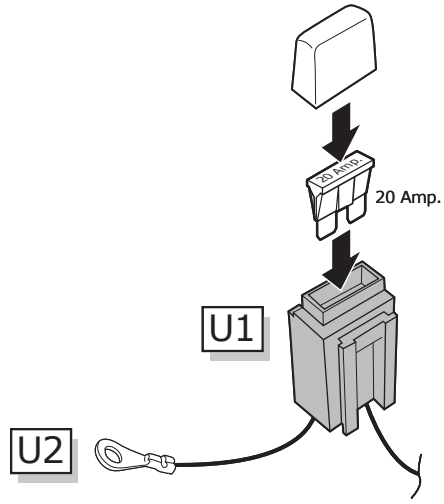

9

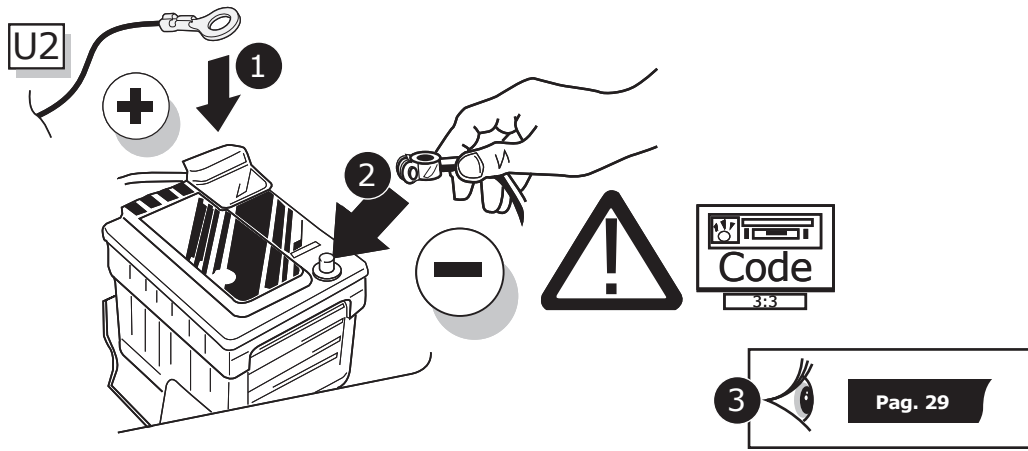

**BMW 6 Series
(Grand) Coupé
(F13, F06)
03/2015-**

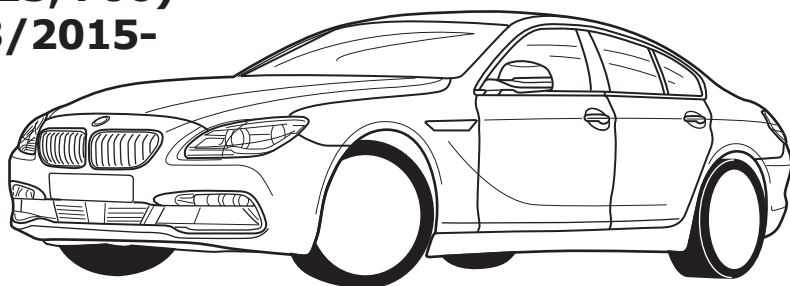

Pag. 23 - 30

ROUTING

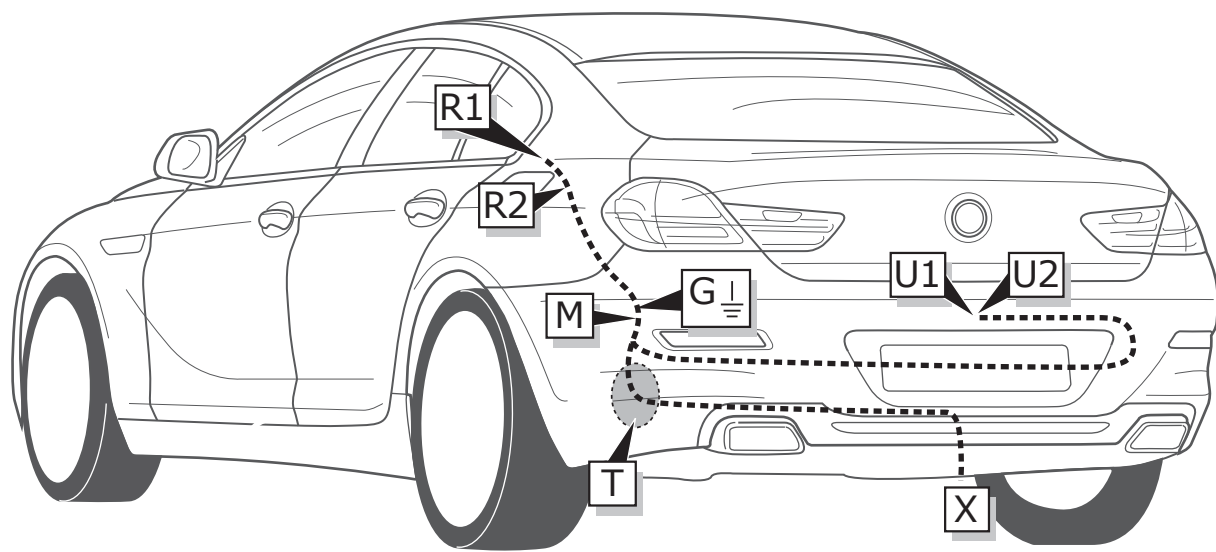

1

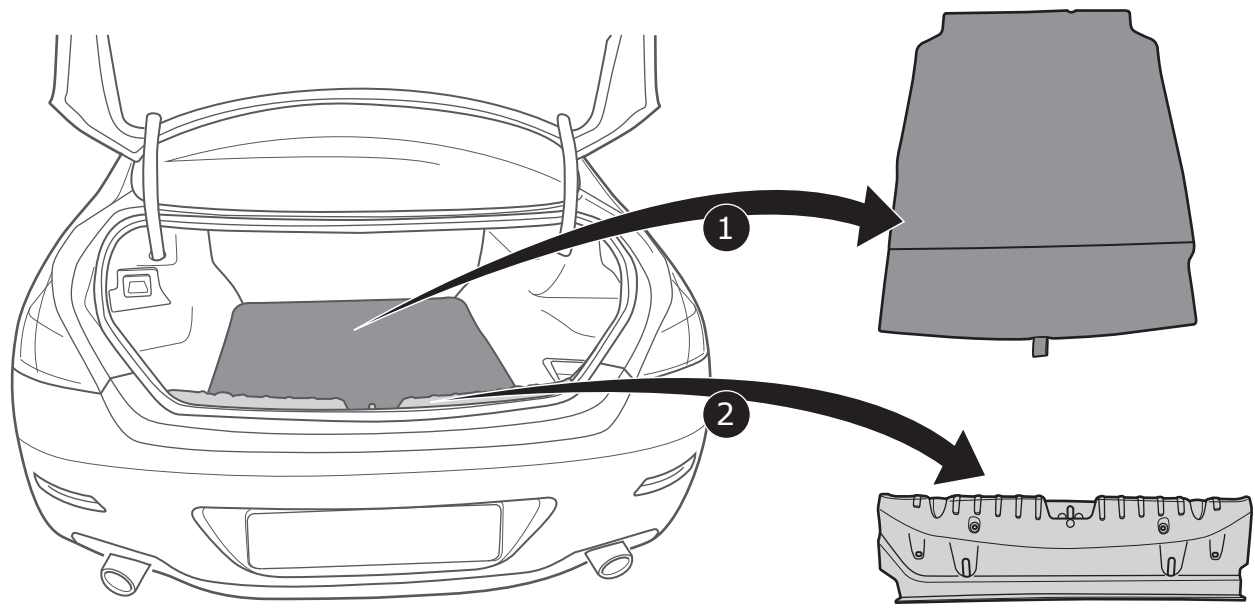

2

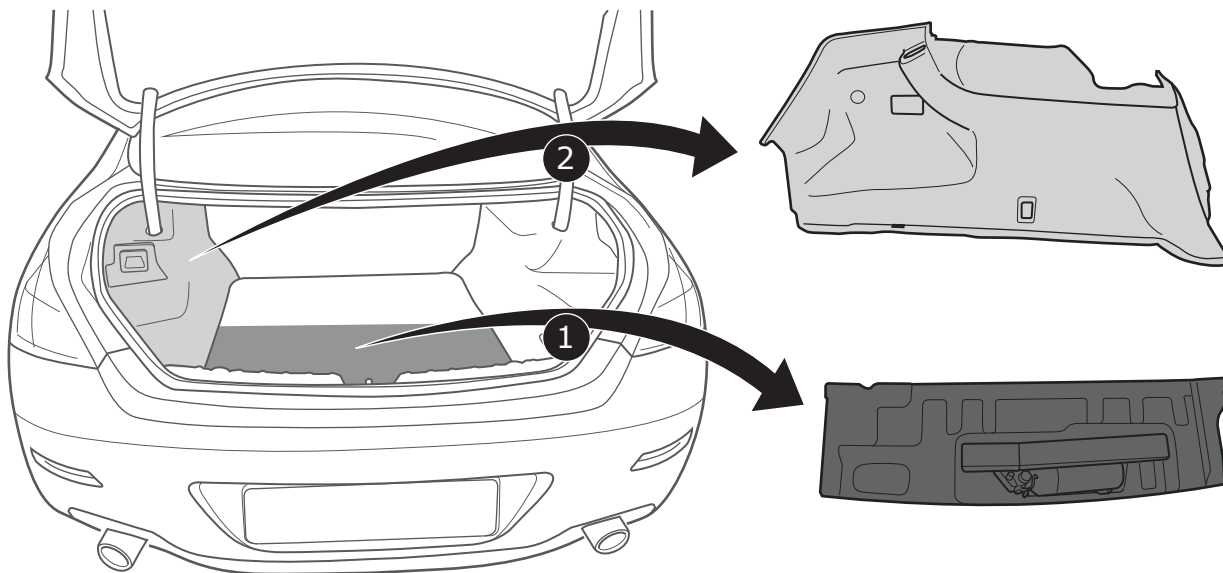

3

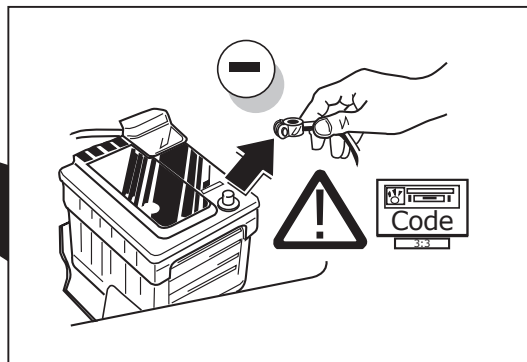
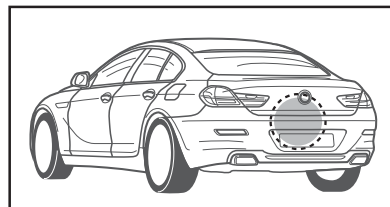
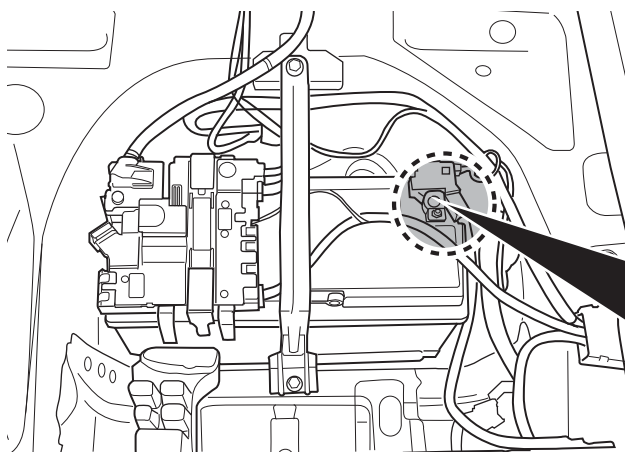

4

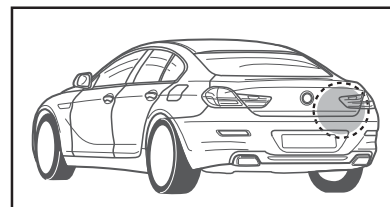
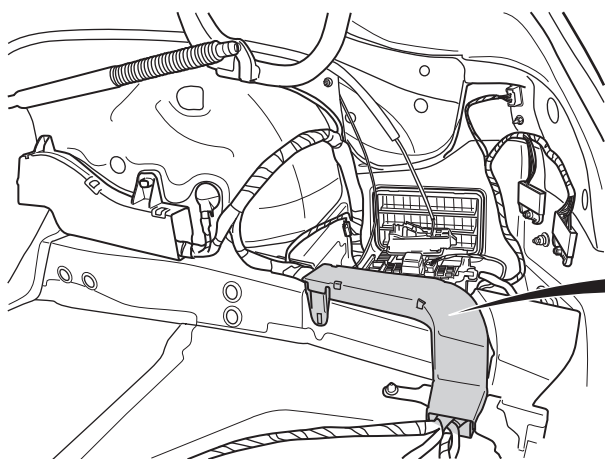

5

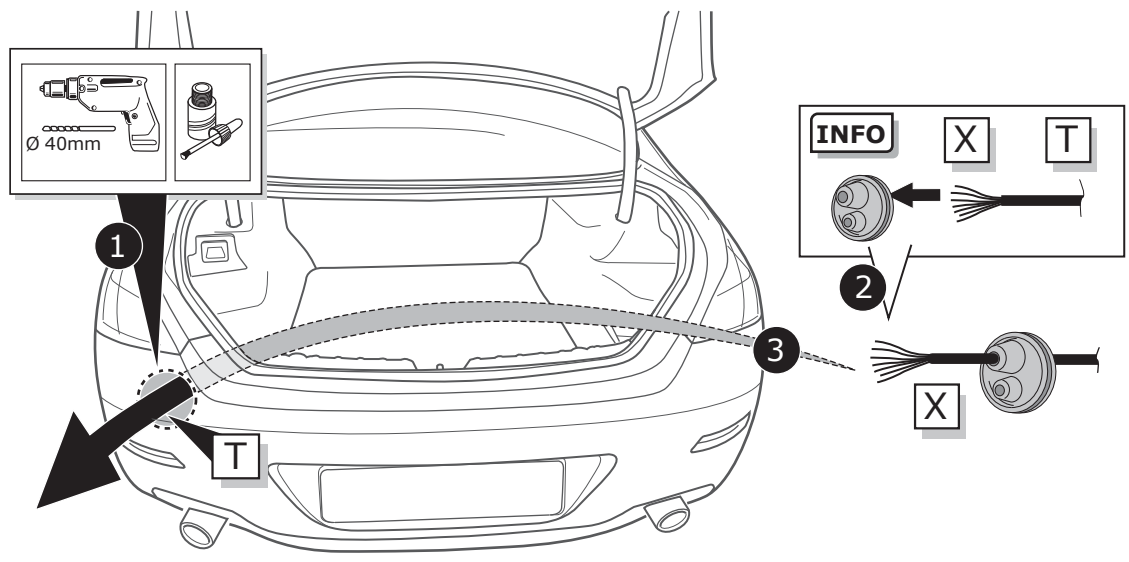

INFO

SOCKET CONNECTION  **Pag. 30**

6

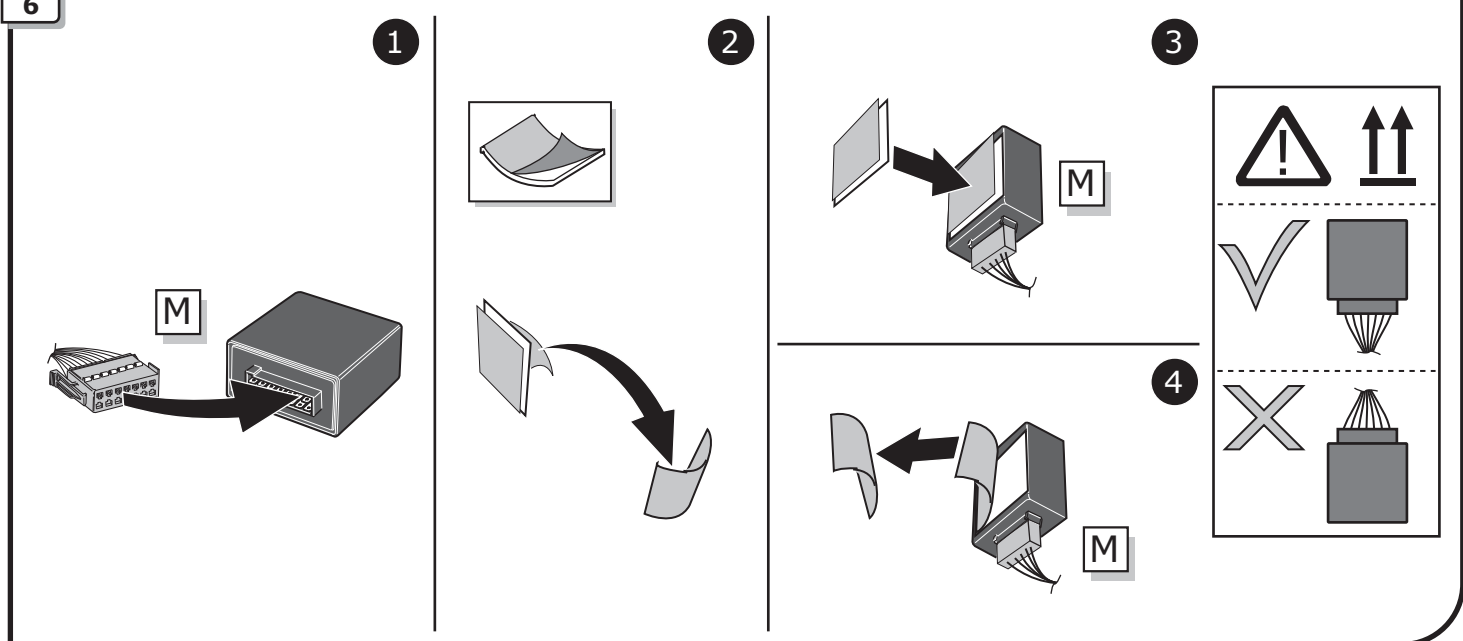

7

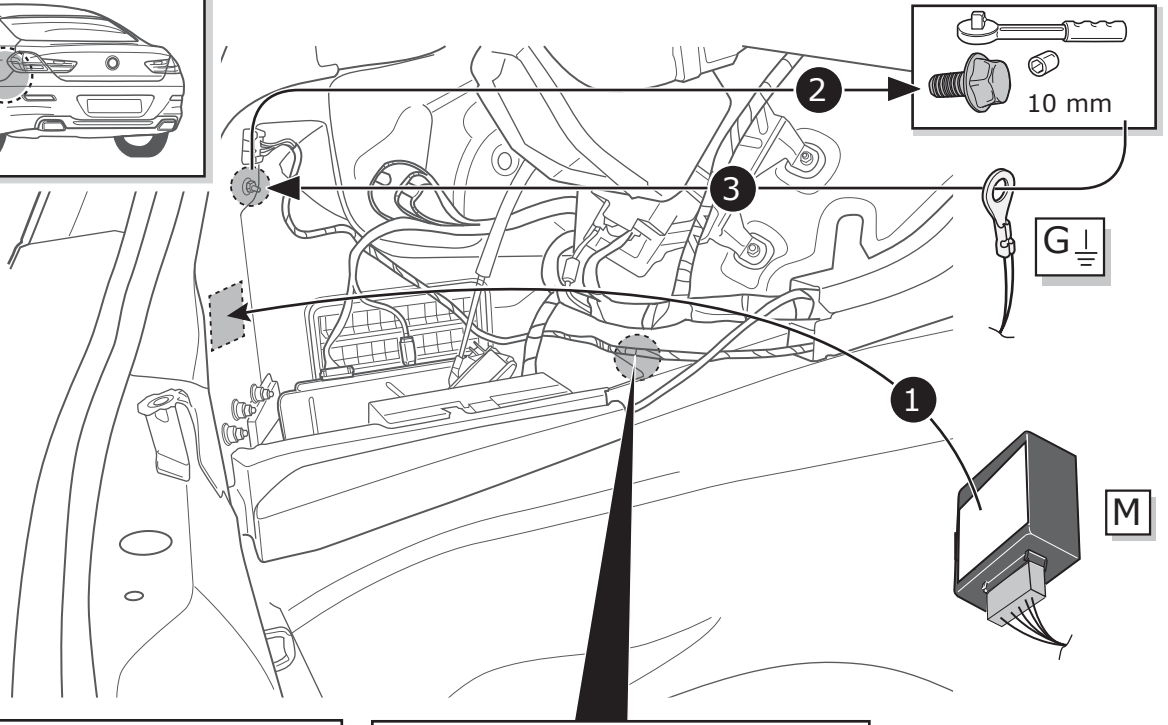
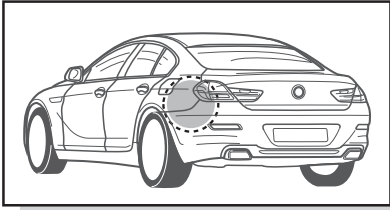

4

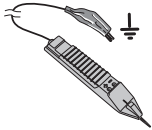

5

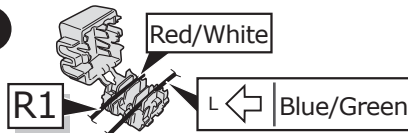

6

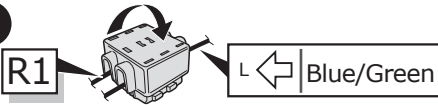

8

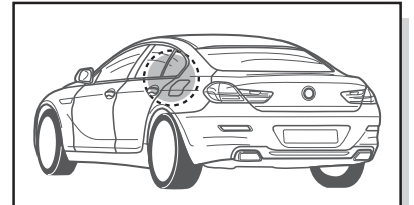
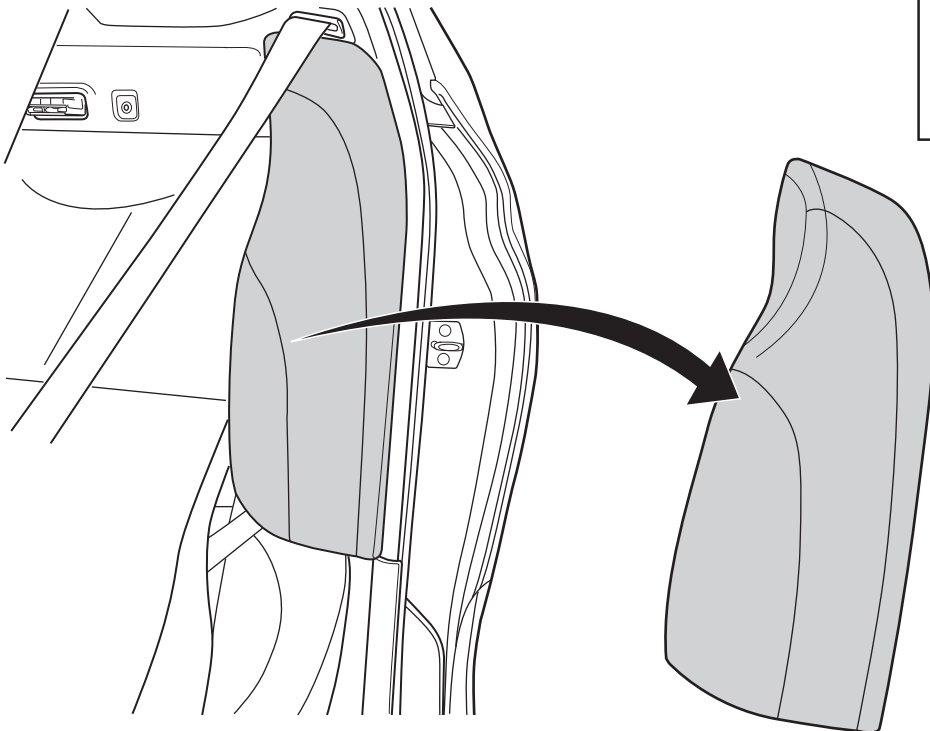

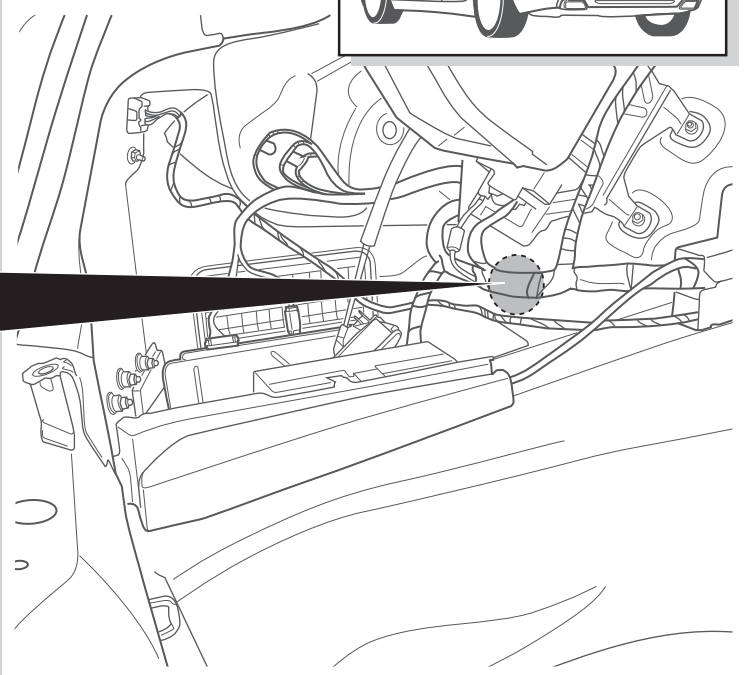
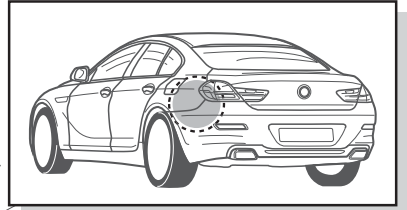
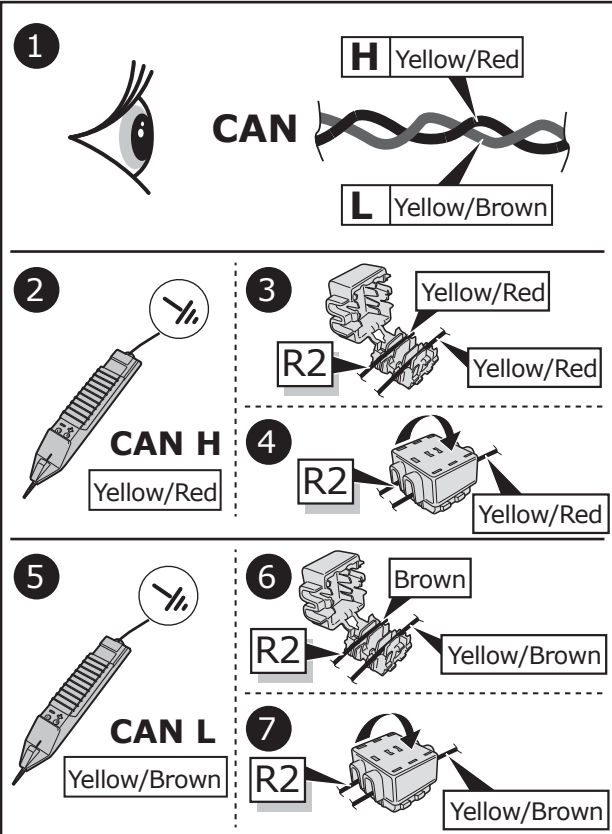
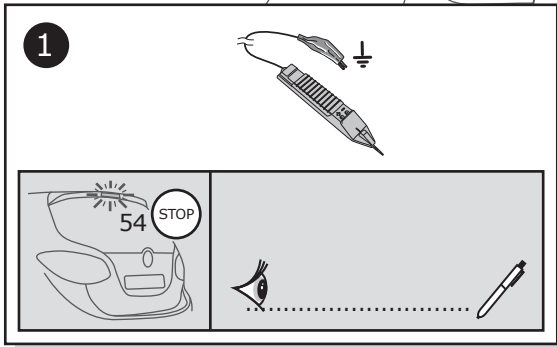
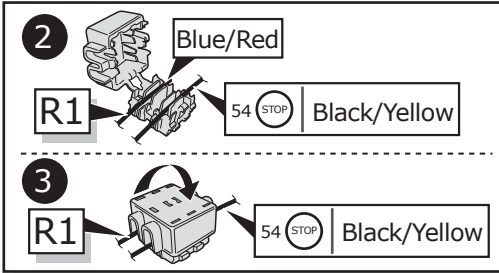
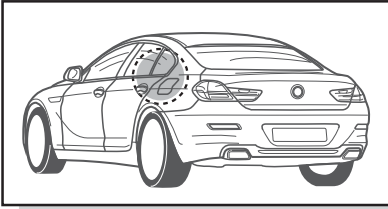

11

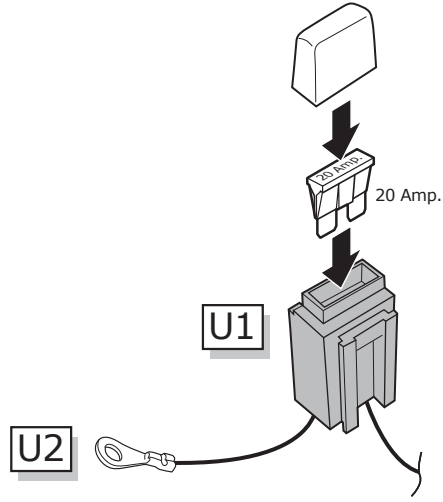
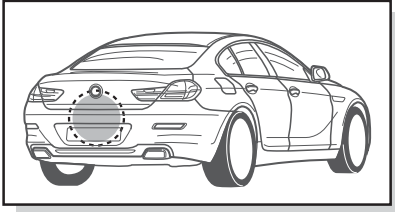

12

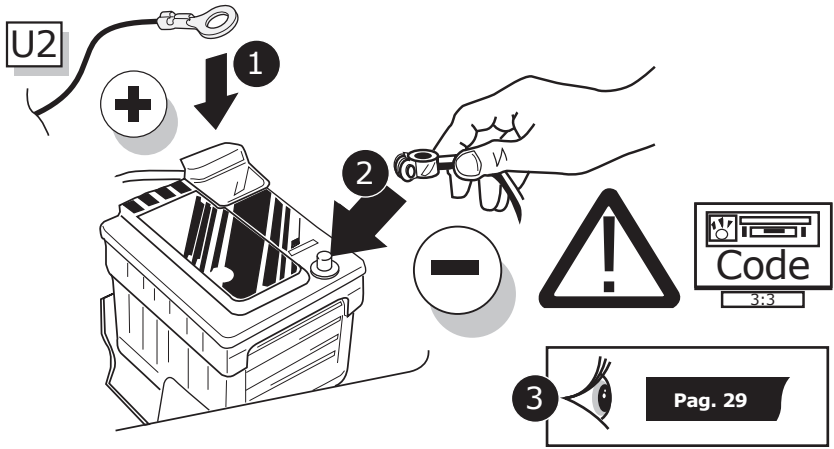
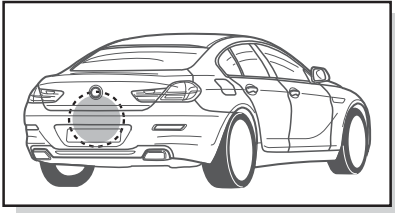

A

TEST ALL THE CIRCUITS WITH A TEST DEVICE WITH THE CORRECT POWER LOAD FOR EACH FUNCTION. A TEST DEVICE WITH LED'S CANNOT BE USED FOR THIS PURPOSE.

INFO

REINSTALL TRIM.

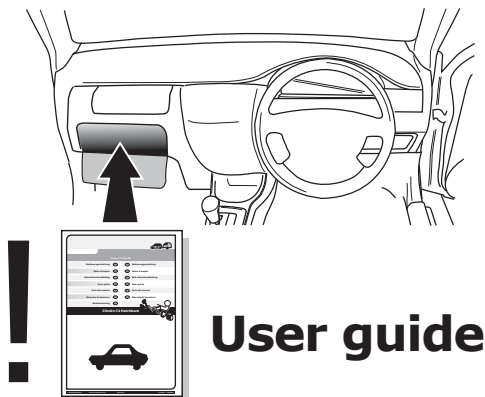
B**INFO**

SOCKET CONNECTION

DIN/ISO 1724							
	1/L	2	3/31	4/R	5/58-R	6/54	7/58-L
Pmax	21W	21W		21W	42W	3x21W	42W
Colour	Yellow	Blue	White	Green	Brown	Red	Black

A

Option 1

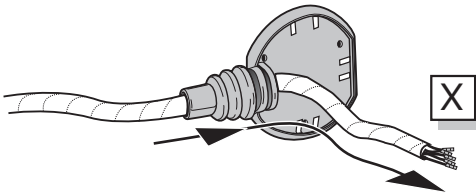

Option 2

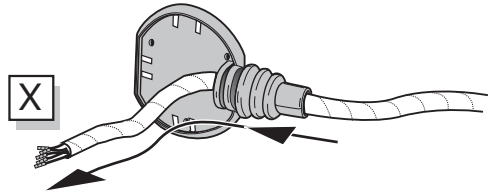

INFO

SOCKET CONNECTION



Pag. 29

B

Option 1

1

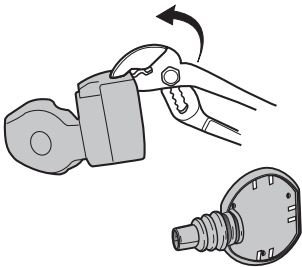

2

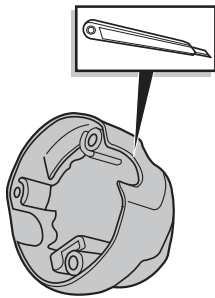

3

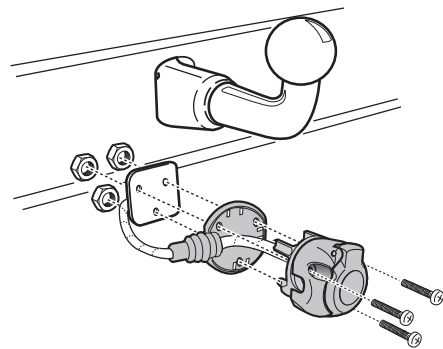

C

Option 2

1

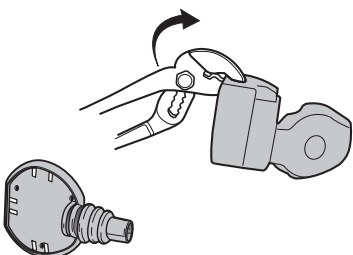

2

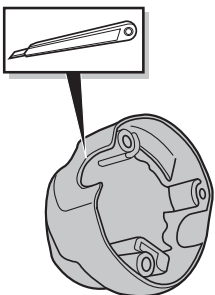

3

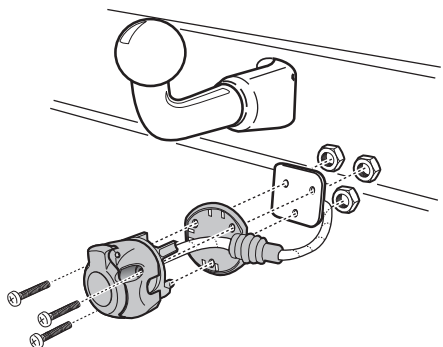

UN-243-YZ Reverse lamp pre-wire extension

⚠ MAX = 21W

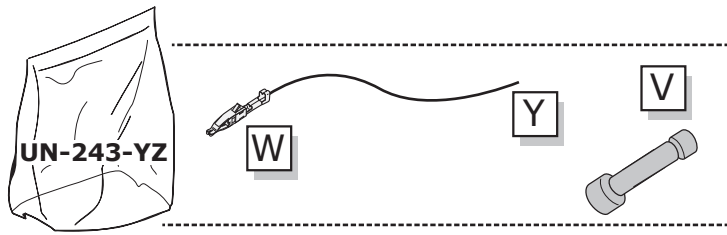

A

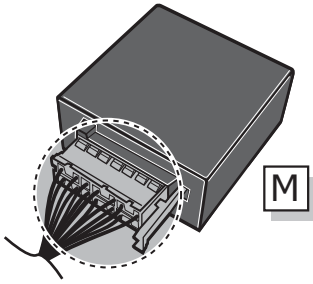

1

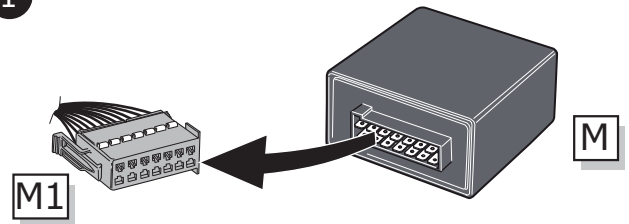

2

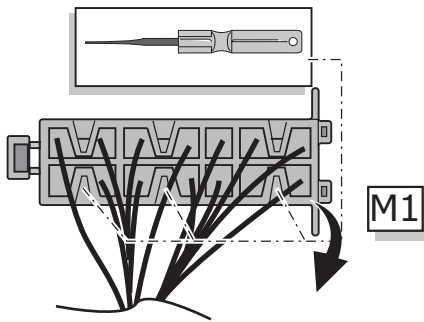

3

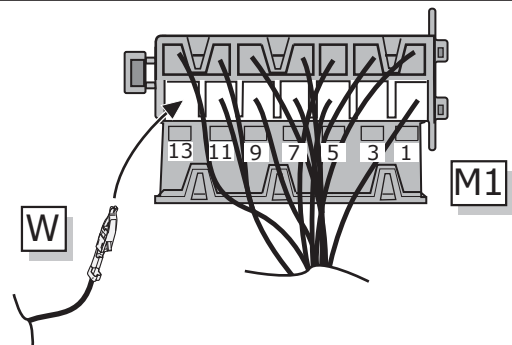

4

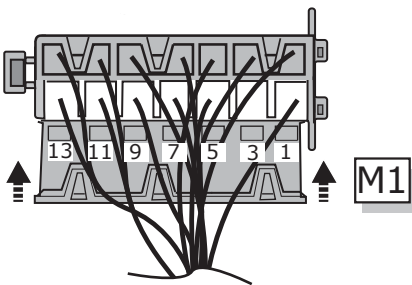

5

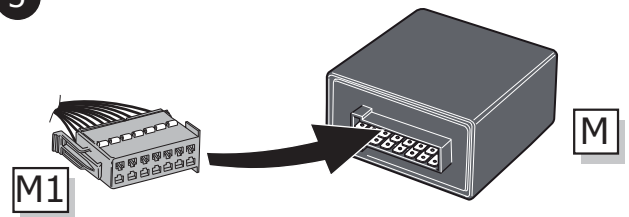

B

⚠ MAX = 21W

