

Ford Ranger 2012 >>

Partnr.: FR-053-D1U

- Fitting instructions electric wiring kit tow bar with 13-P socket up to DIN/ISO Norm 11446.
- We would expressly point out that assembly not carried out properly by a competent installer will result in cancellation of any right to damage compensation, in particular those arising by virtue of the product liability act.
- Contents of these kits and their fitting manuals are subject to alteration without notice, please ensure that these instructions are read and fully understood before commencing installation.
- Do not overload circuits; the maximum loads per connection are detailed in this manual.
- Attention! Before Installation, please read this manual carefully and inform your customer to consult the vehicle owners manual to check for any vehicle modifications required before towing.
- In the event of functional problems, troubleshooting must be limited to about 0.5 hours, contact the technical support:
ukts@ecs-electronics.com / 07440 202 052.



Part list

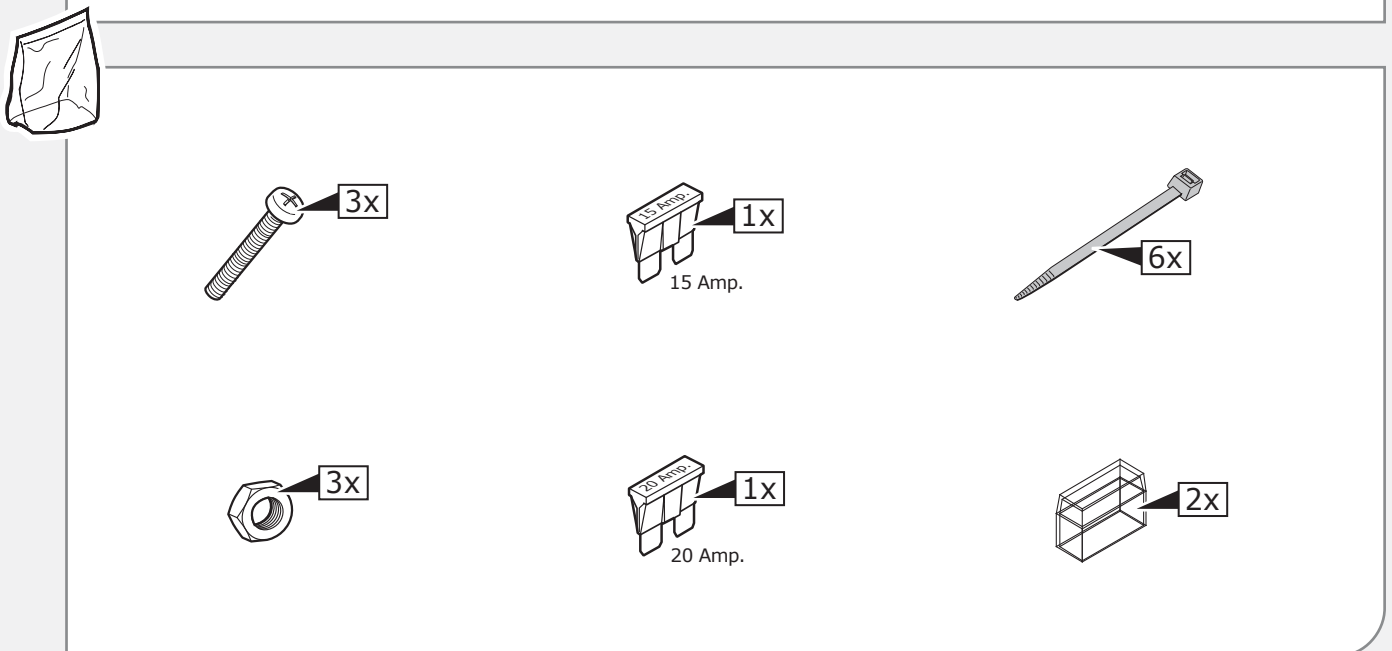
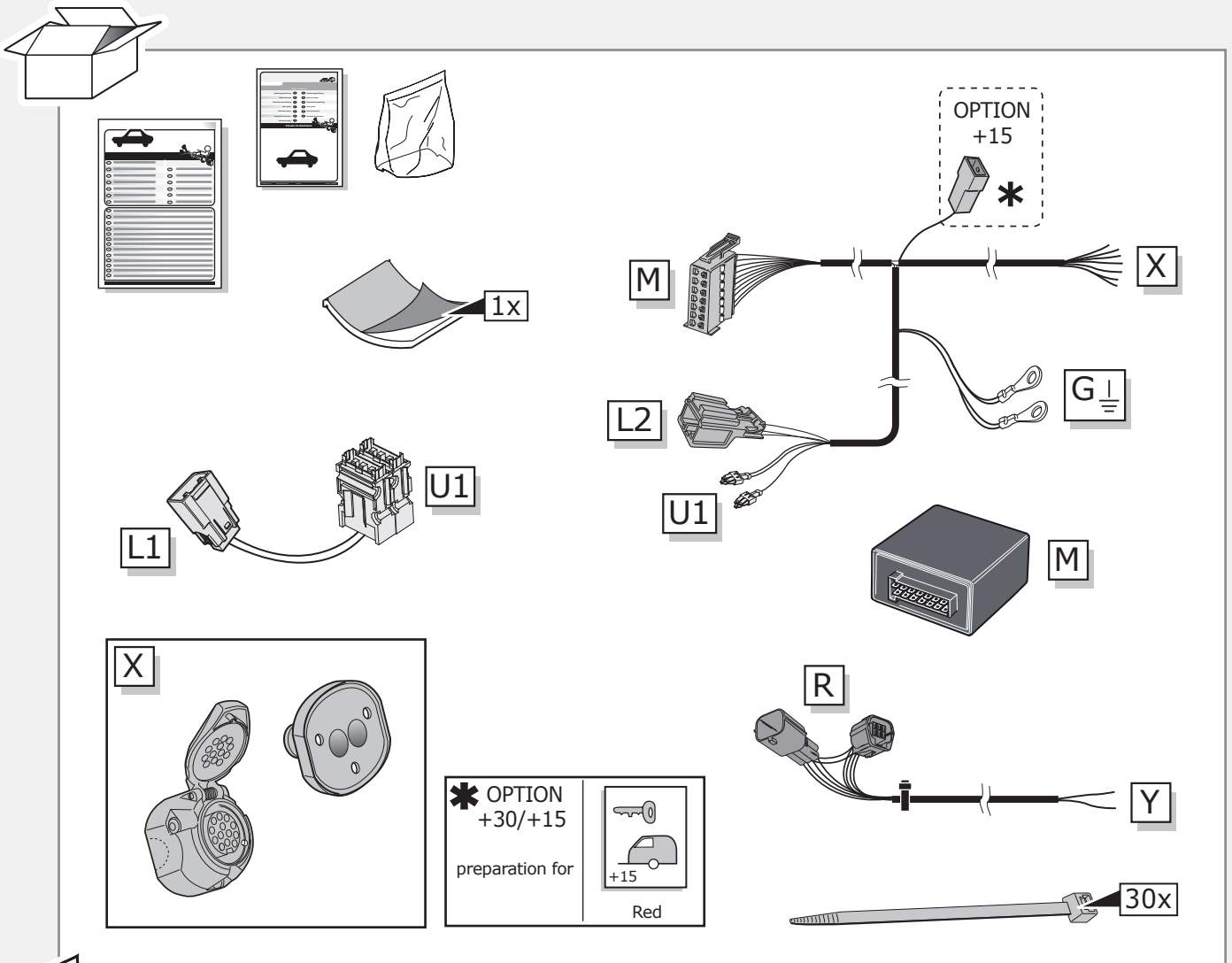

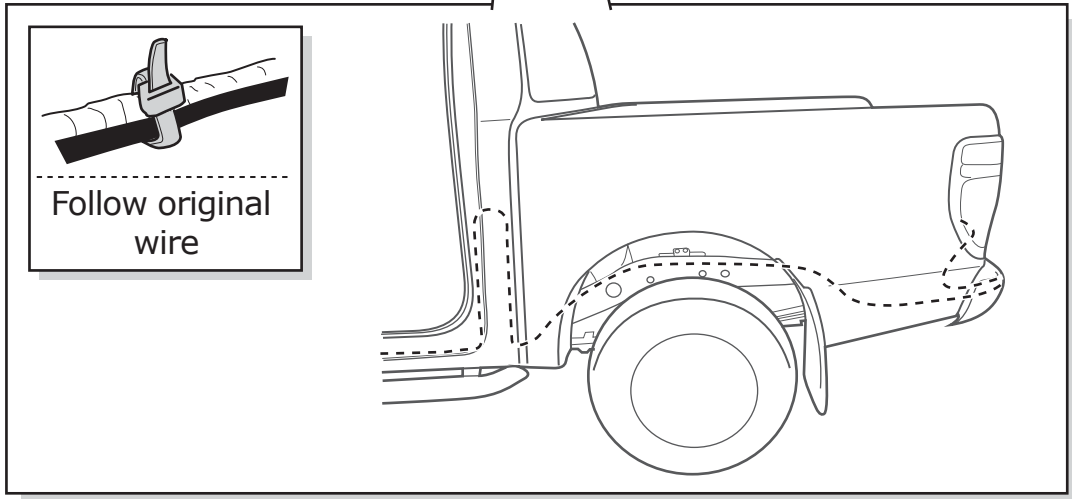
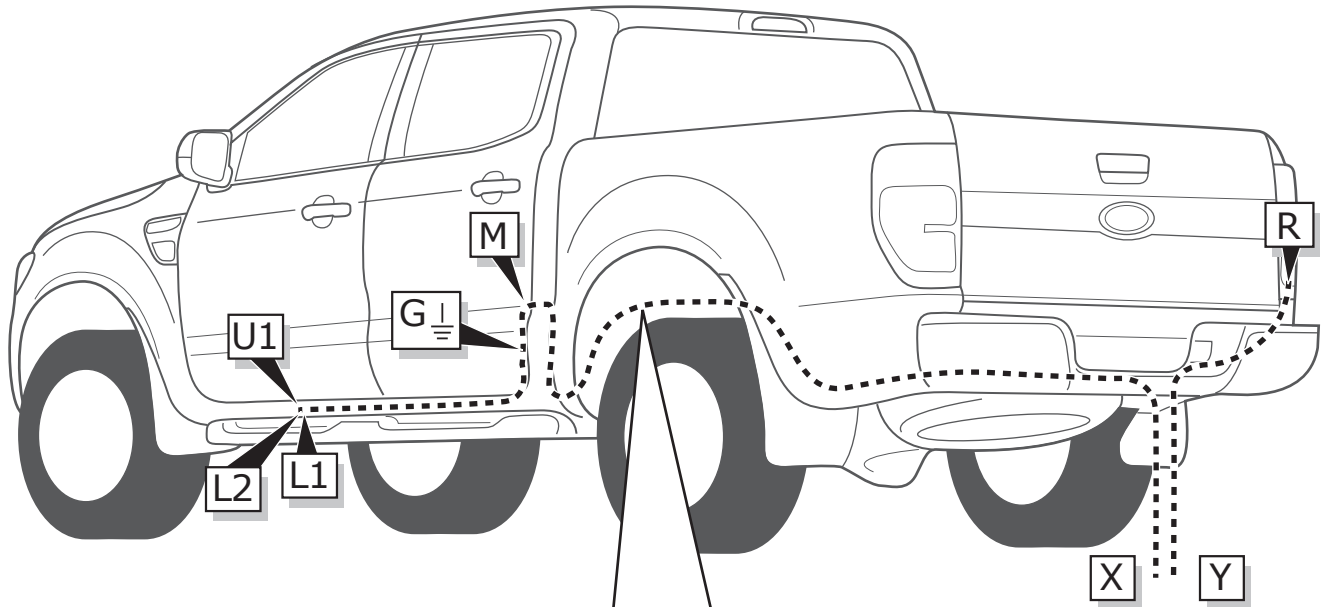

1

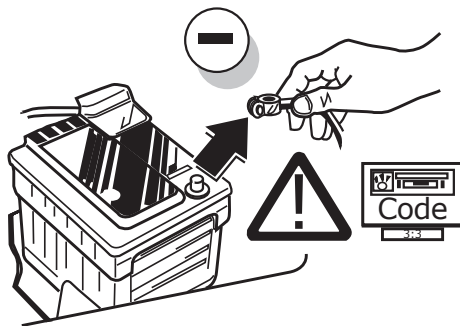

2

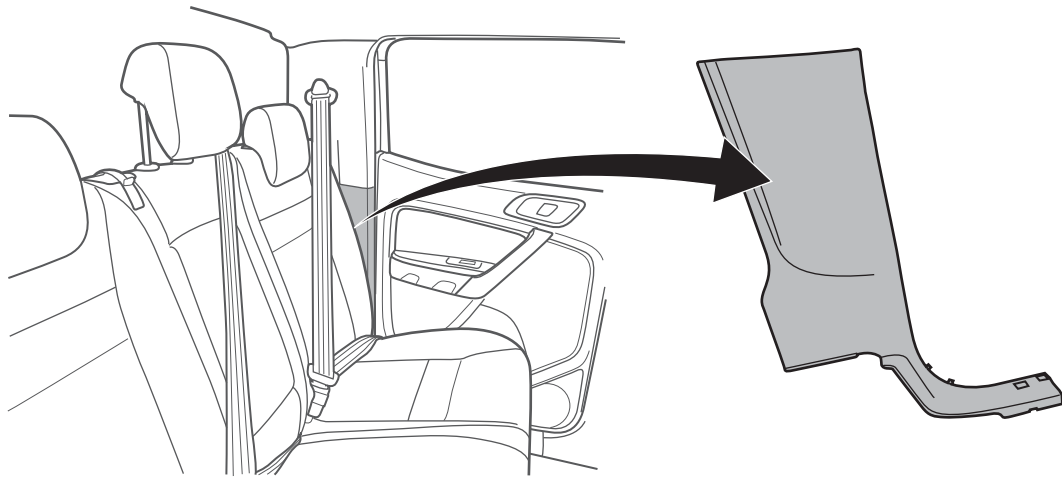

3

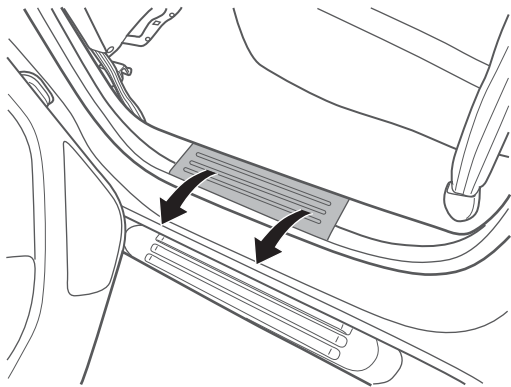
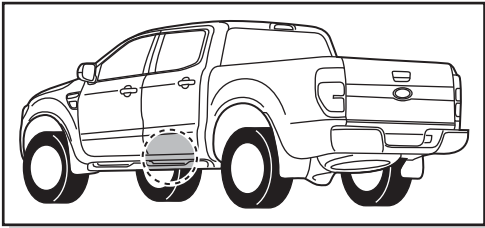

4

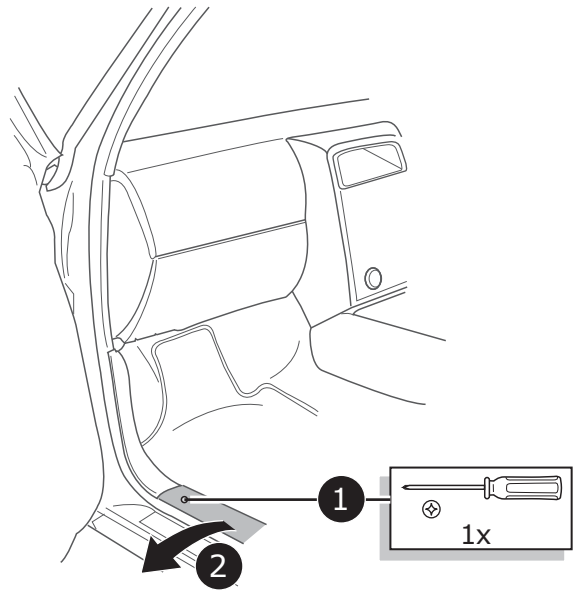

5

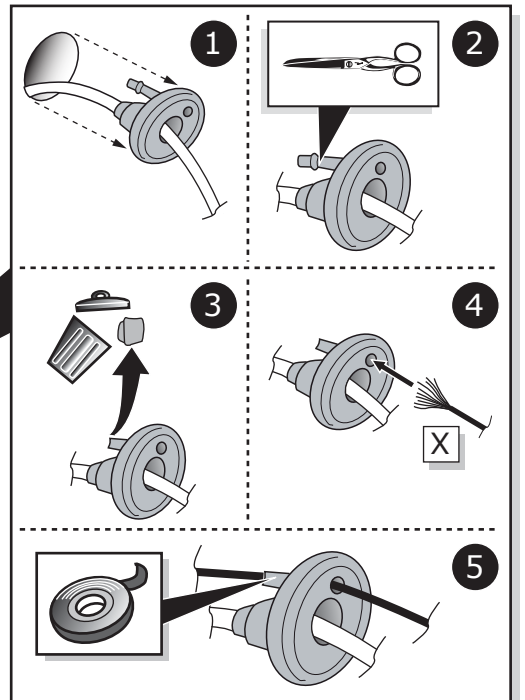
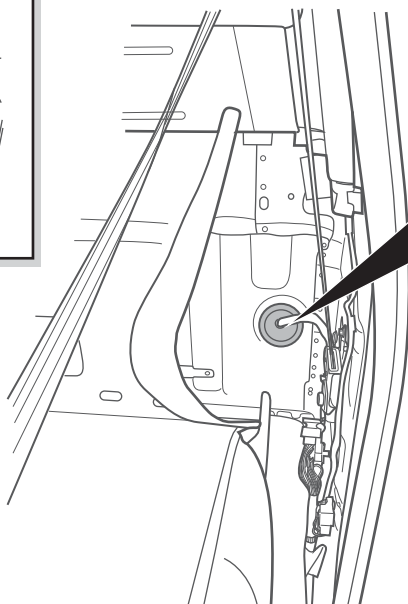
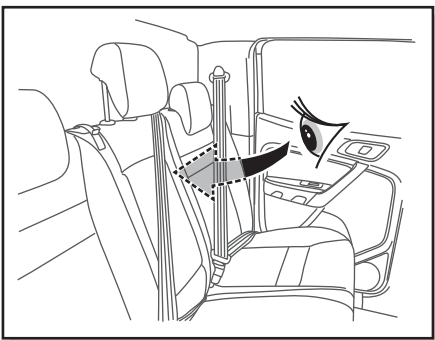

6

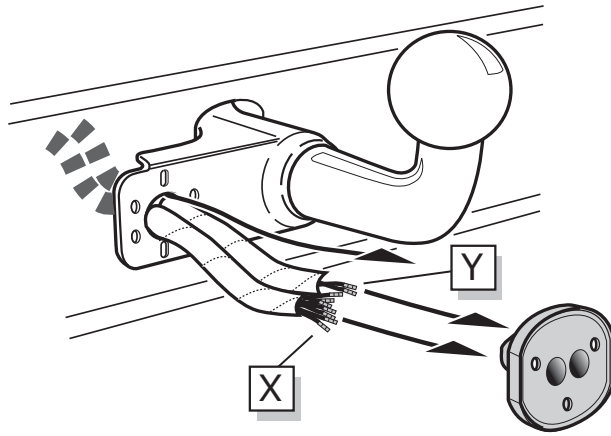

7

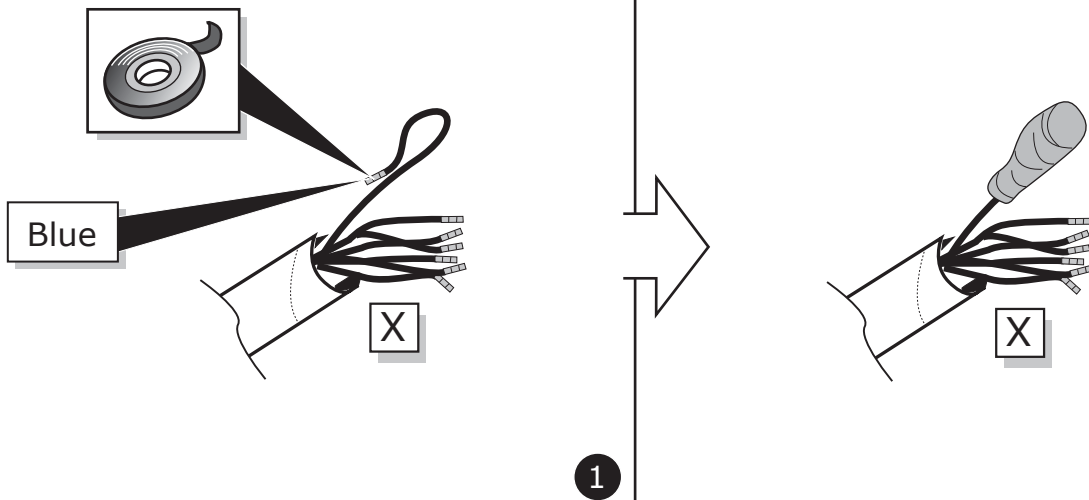

INFO

SOCKET CONNECTION  **Pag. 10**

8

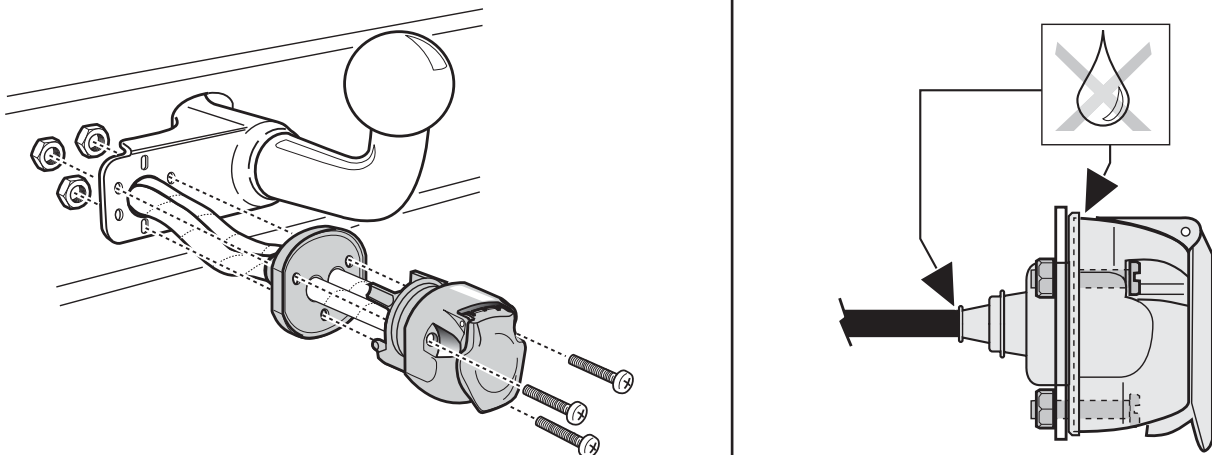

9

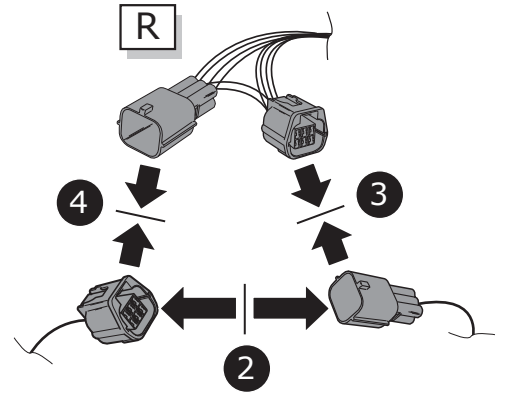
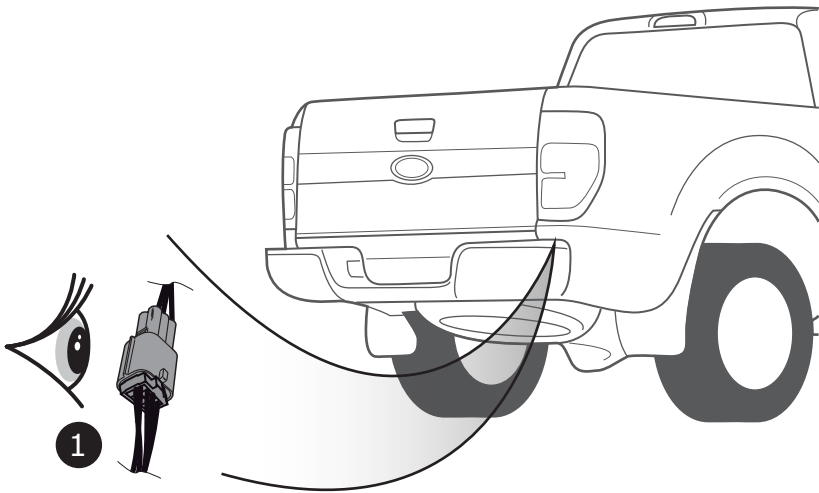

10

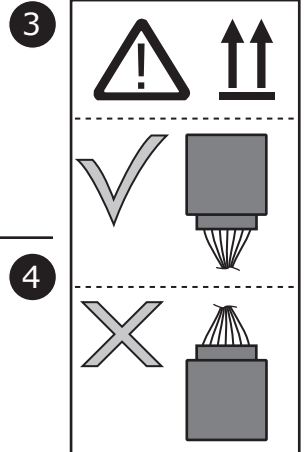
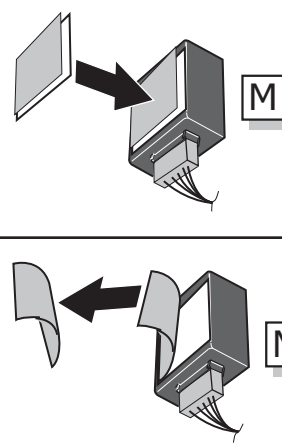
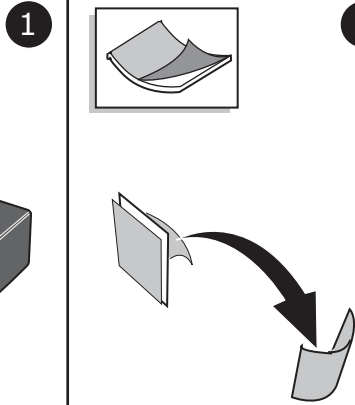
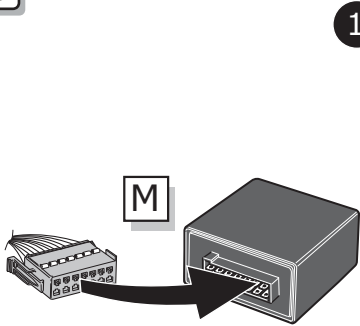

11

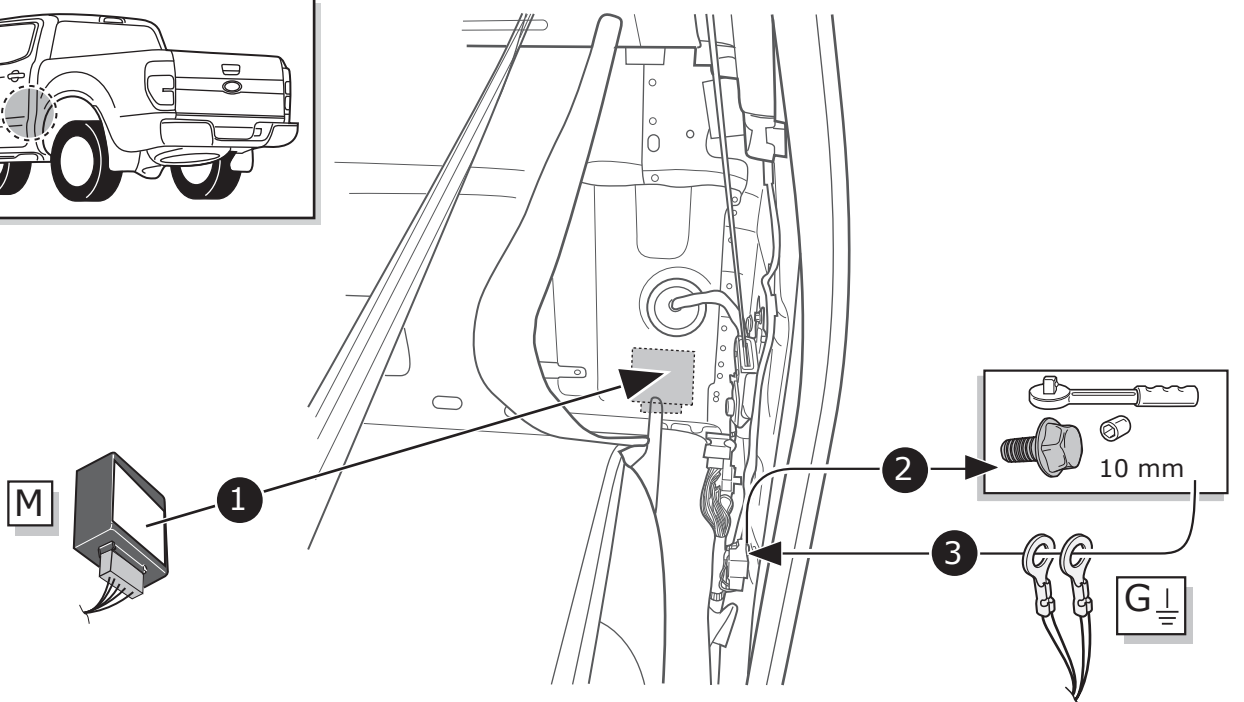
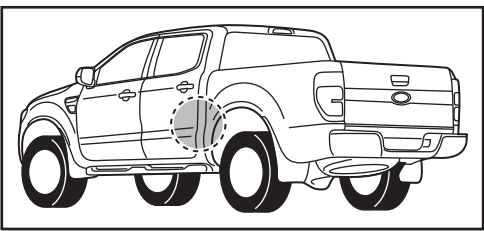

12

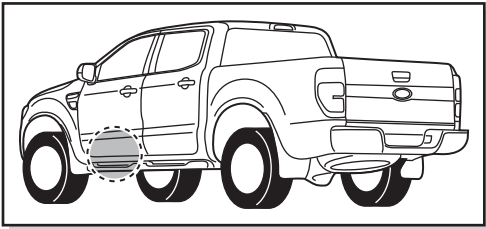

Option 1

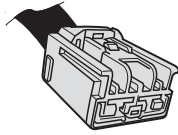

2pole Grey

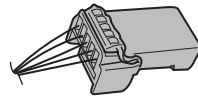

5pole Green

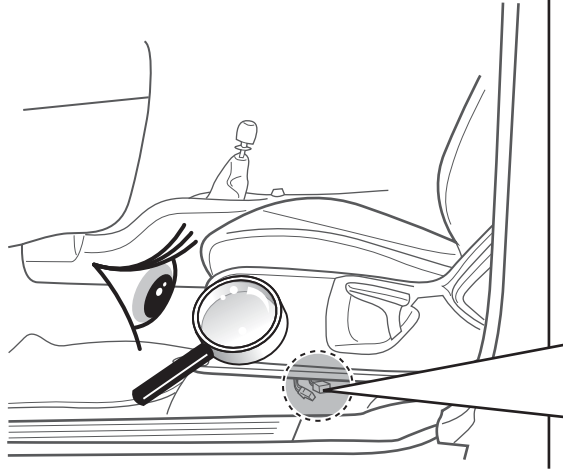

Option 2

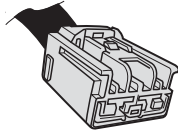

2pole Grey

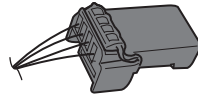

4pole Black

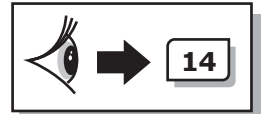

13

Option 1

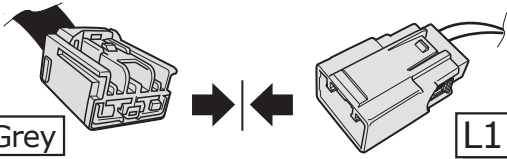

2pole Grey

L1

1

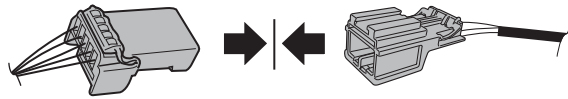

5pole Green

L2

2



14

Option 2

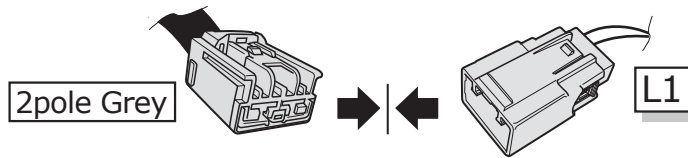

2pole Grey

L1

1

4pole Black

L2

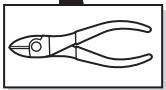
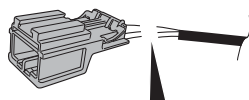
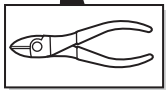
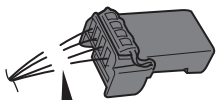

2



Brown	→	Grey/Orange
Green	→	Purple/Orange
Blue/Red	→	Black/Blue

3

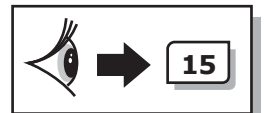

15

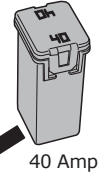
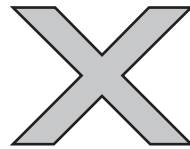
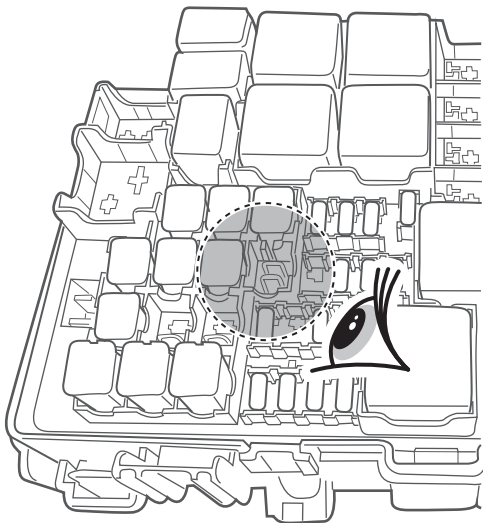
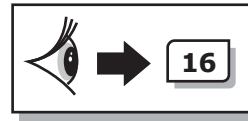
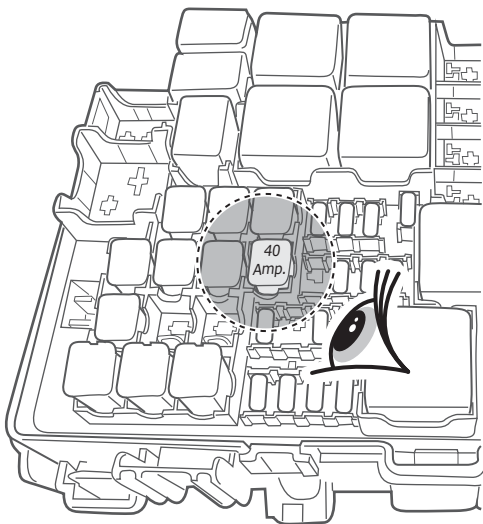

GENUINE FORD Part

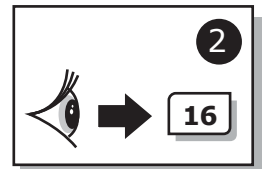
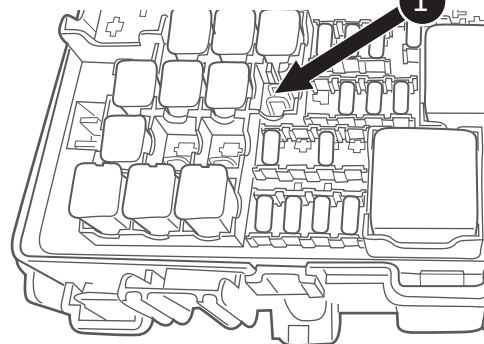

16

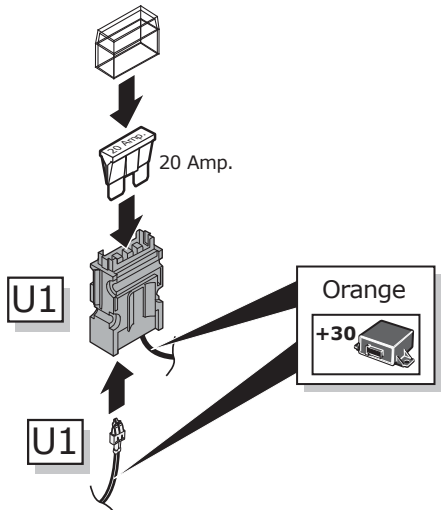

1

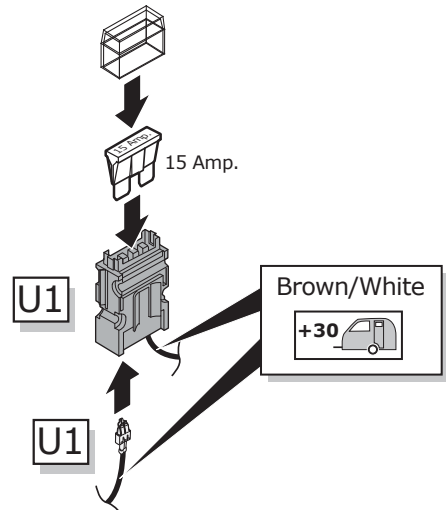

2

17

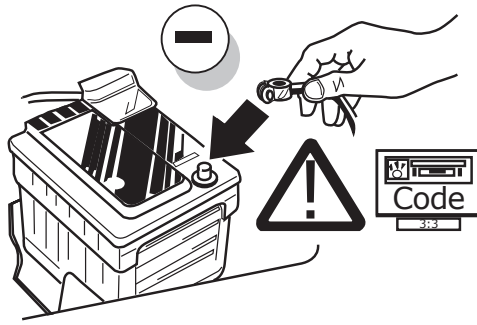

18



19



TEST ALL THE CIRCUITS WITH A TEST DEVICE WITH THE CORRECT POWER LOAD FOR EACH FUNCTION. A TEST DEVICE WITH LED'S CANNOT BE USED FOR THIS PURPOSE.

INFO

REINSTALL TRIM.



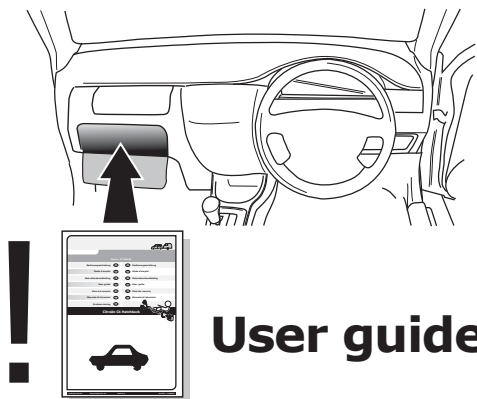











20



User guide



SOCKET CONNECTION

DIN/ISO 11446														
	1/L	2	2a	3/31	4/R	5/58-R	6/54	7/58-L	8	9	10	11	12	13
Pmax	21W	21W			21W	42W	3x21W	42W	21W	180W/15Amp	180W/15Amp			
Colour	Yellow	Blue	Grey	White	Green	Brown	Red 1,00 mm ²	Black	Black/ Red	Brown/ White	Red 2,50 mm ²	White	-	White