

! INFO !

Do not charge the battery of the towing vehicle and/or towed vehicle directly via the socket.

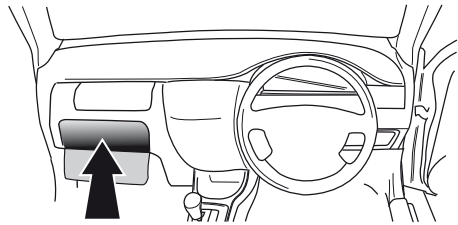

User guide

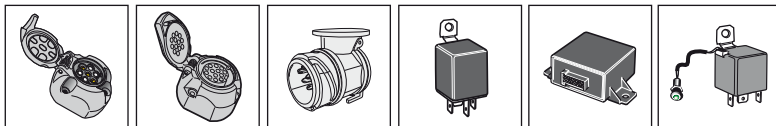

SPARE PARTS

www.ukts@ecs-electronics.com



Partnr.: FR-066-D1U

User Guide



Ford Transit Connect 01/2014 >> 06/2018
Ford Tourneo Connect 01/2014 >> 06/2018

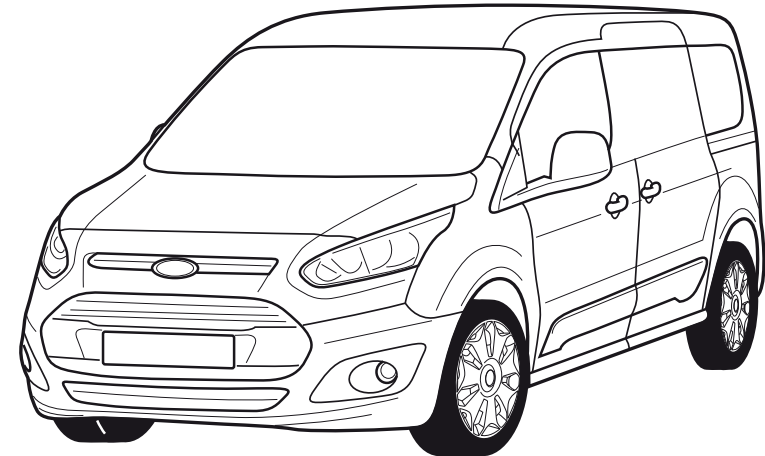

INFO

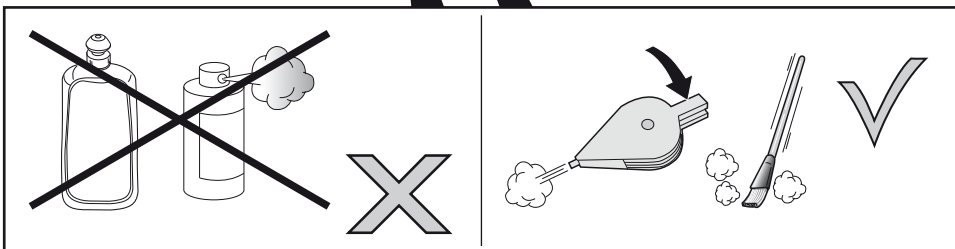
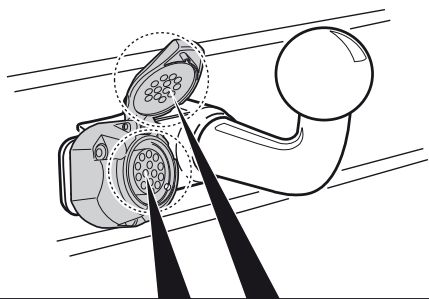
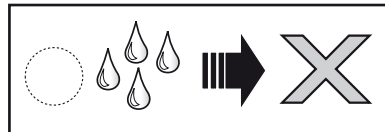
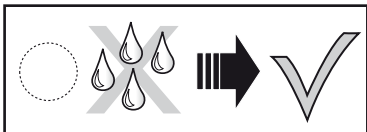
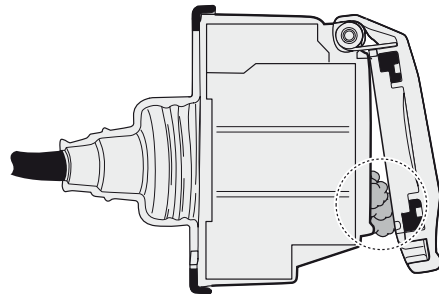
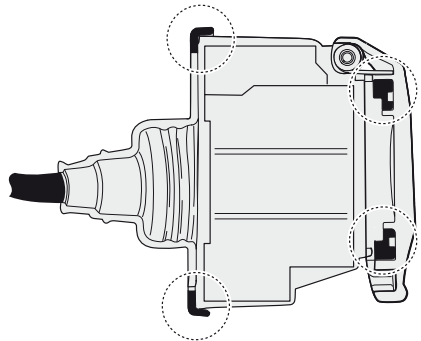
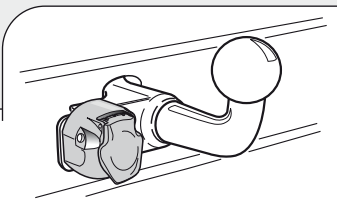
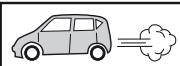

INFO : Ring.

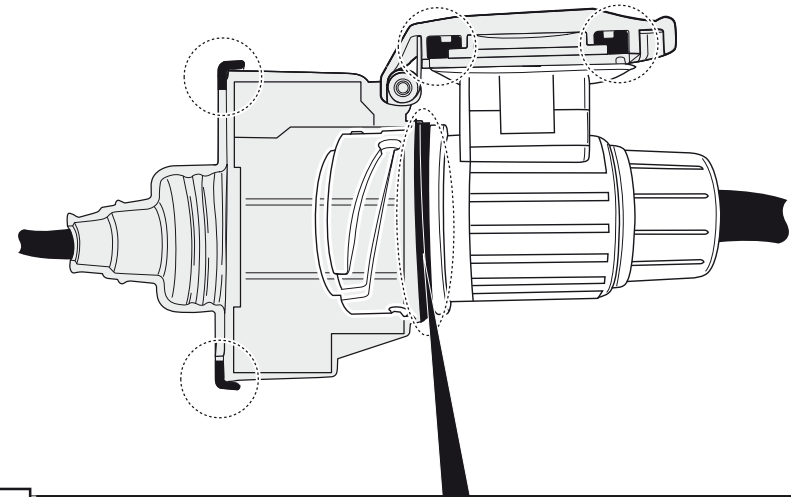
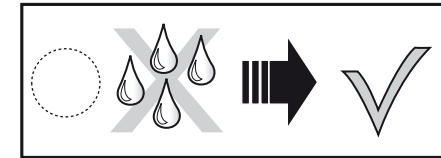
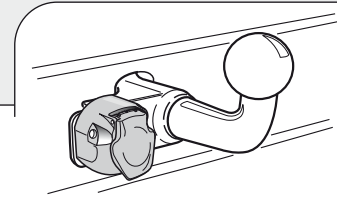
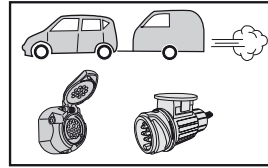

INFO

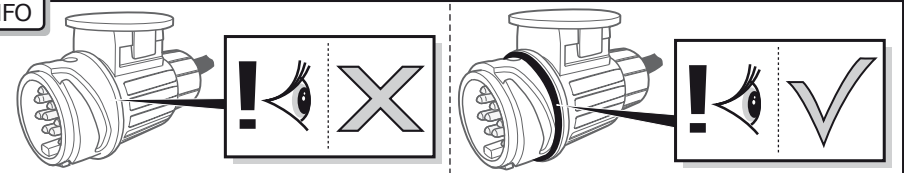

INFO : Adapt.

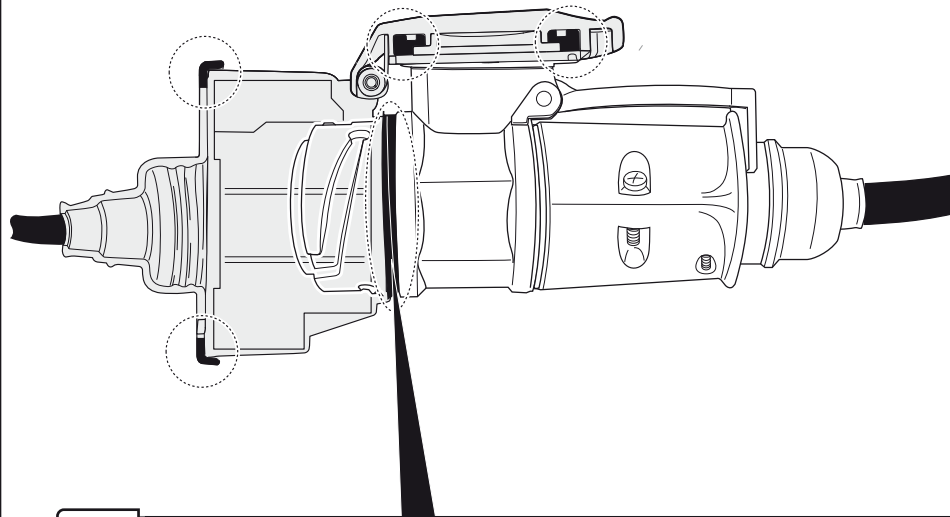
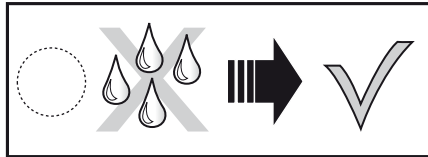
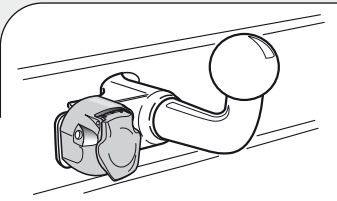
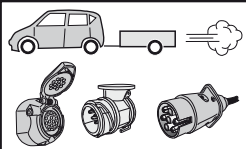

INFO

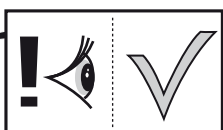
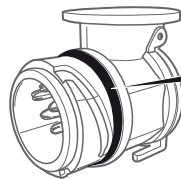
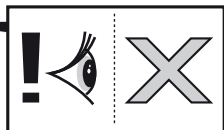
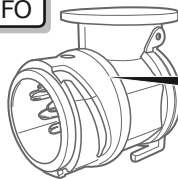

SOCKET CONNECTION

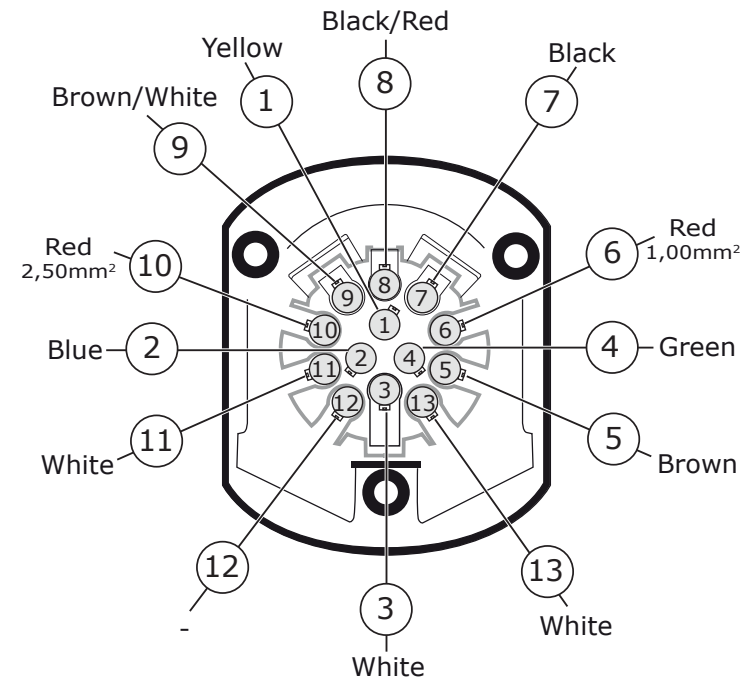
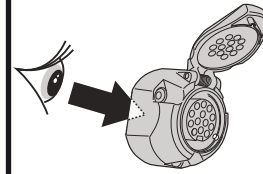

SOCKET CONNECTION

DIN/ISO 11446	↔	⚡	⚡ 1-8	↔	☀️	STOP	☀️	Reverse	30V	15V	⚡ 10	—	⚡ 9
	1/L	2	3/31	4/R	5/58-R	6/54	7/58-L	8	9	10	11	12	13
Pmax	21W	21W	21W	42W	42W	3x21W	42W	21W	180W/15Amp	180W/15Amp			
Colour	Yellow	Blue	White	Green	Brown	Red 1,00 mm ²	Black	Black/ Red	Brown/ White	Red 2,50 mm ²	White	-	White

CHANGING THE FUSE

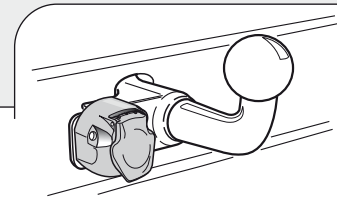
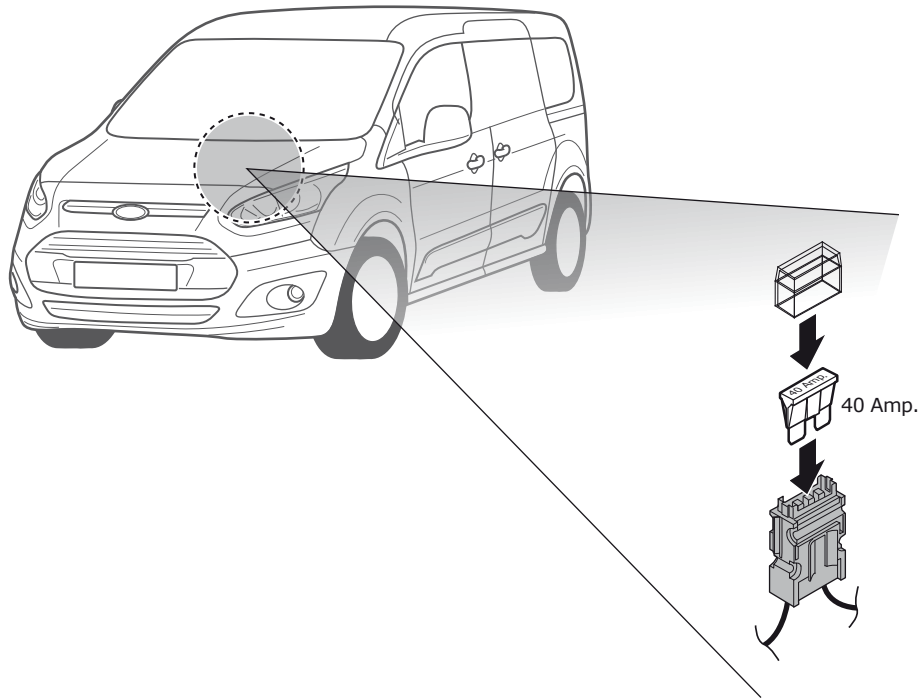
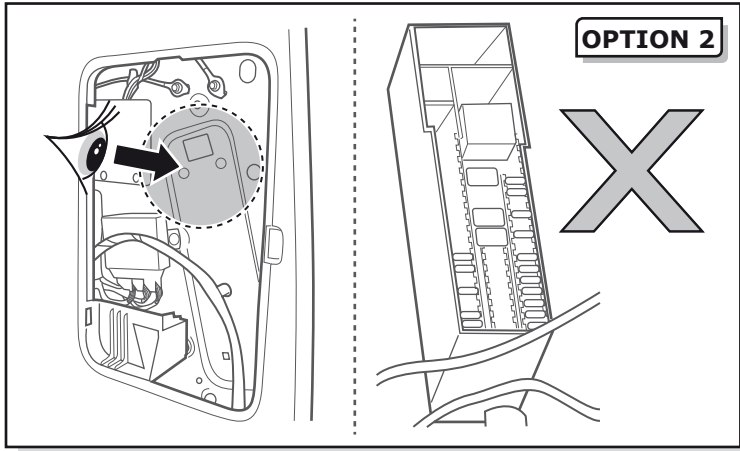

INFO : Storage

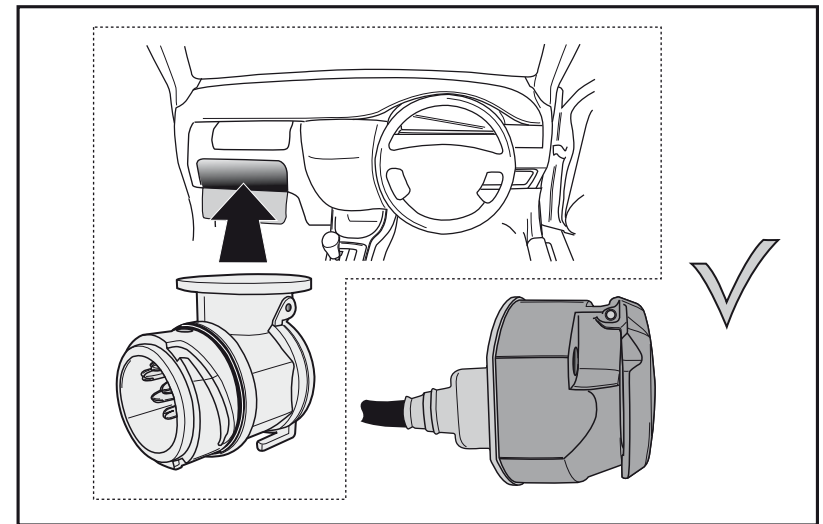
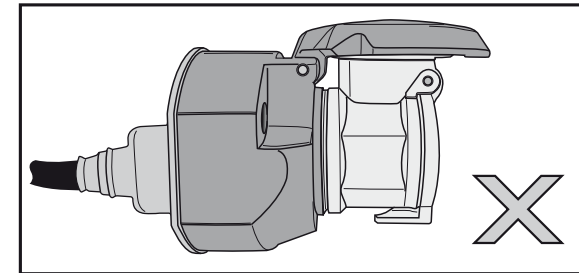
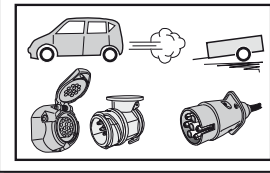



In a coupled trailer with working fog lamp, the fog lamp of the vehicle will be switched off, if applicable.

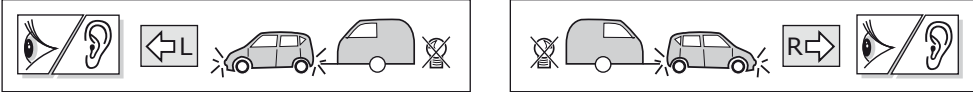

The flashing lights on the trailer are monitored. If one of the indicators of the trailer breaks down, a buzzer will be audible and/or a visual signal will be visible on the dashboard. Check the flashing lights on the trailer.

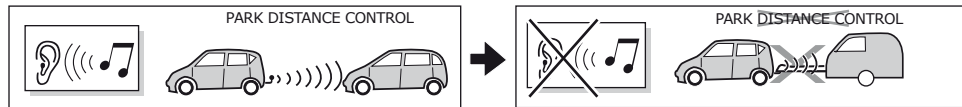

The wiring kit has a possibility to switch off any Park Distance Control in the case of a coupled trailer.

CHANGING THE FUSE

