

**! INFO !**

Do not charge the battery of the towing vehicle and/or towed vehicle directly via the socket.

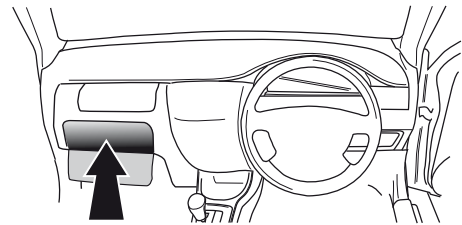

**User guide**

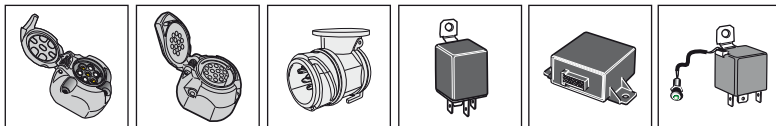

**SPARE PARTS**

**[www.ecs-electronicsuk.co.uk](http://www.ecs-electronicsuk.co.uk)**



Partnr.: OP-052-D1U

**User Guide**

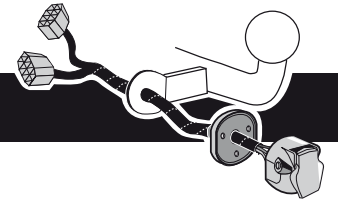

**OPEL**

Astra J Hatchback	12/2009 >>
Astra J Station Wagon	12/2010 >>
Astra Station Wagon	2012 >>
Astra Sedan	2012 >>
Astra GTC	2011 >>
Corsa E	09/2014 >> 10/2019

INFO

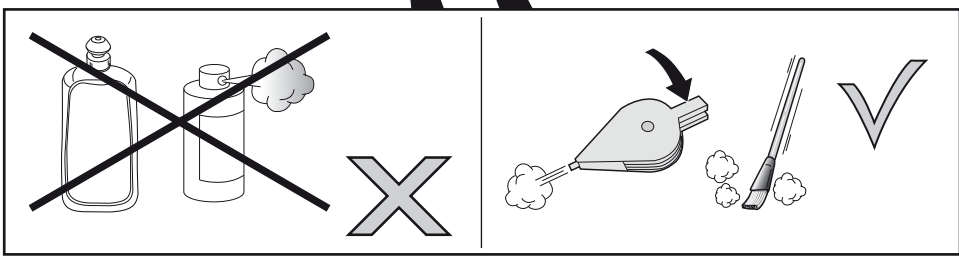
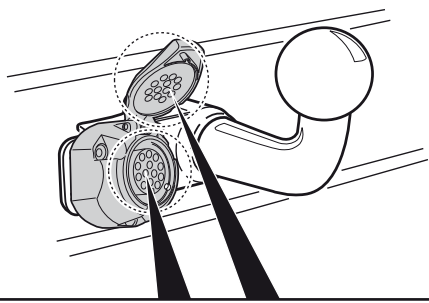
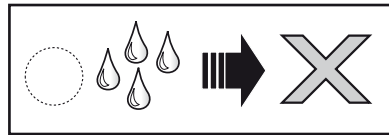
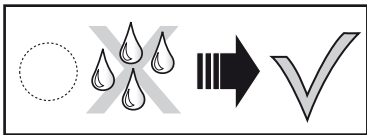
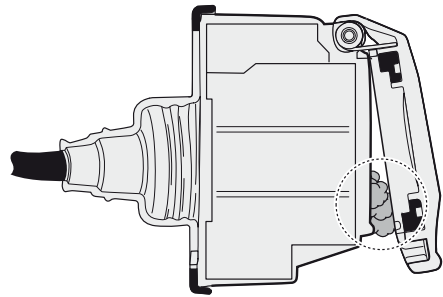
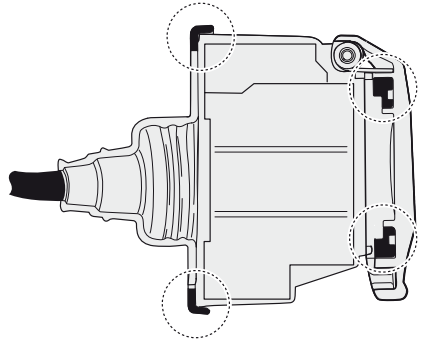
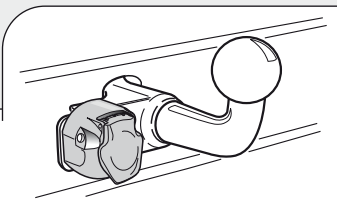
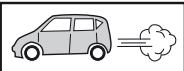

INFO : Ring.

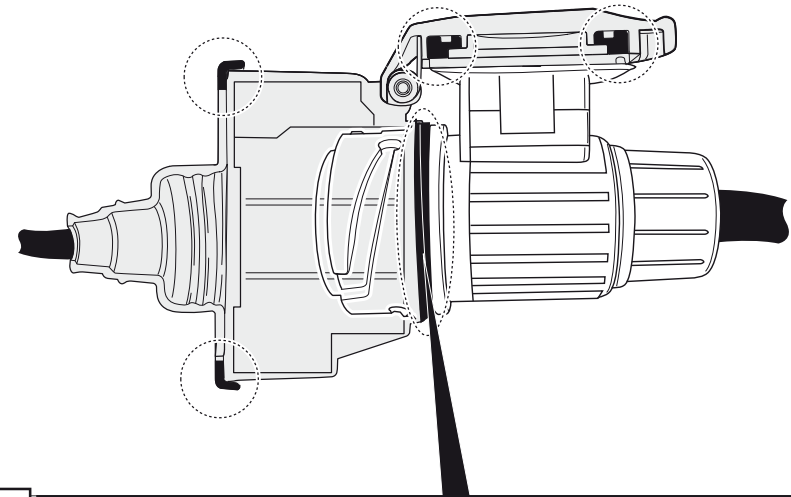
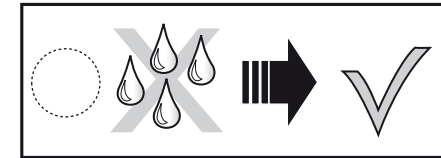
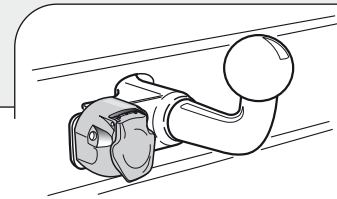
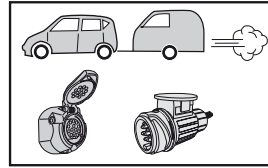

INFO

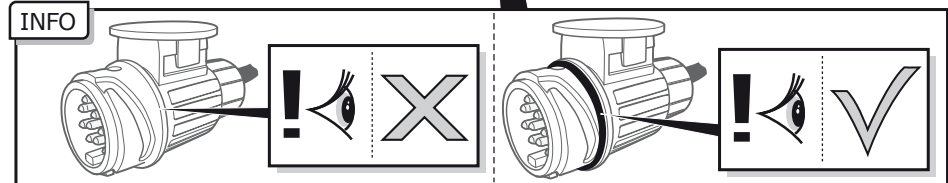

INFO : Adapt.

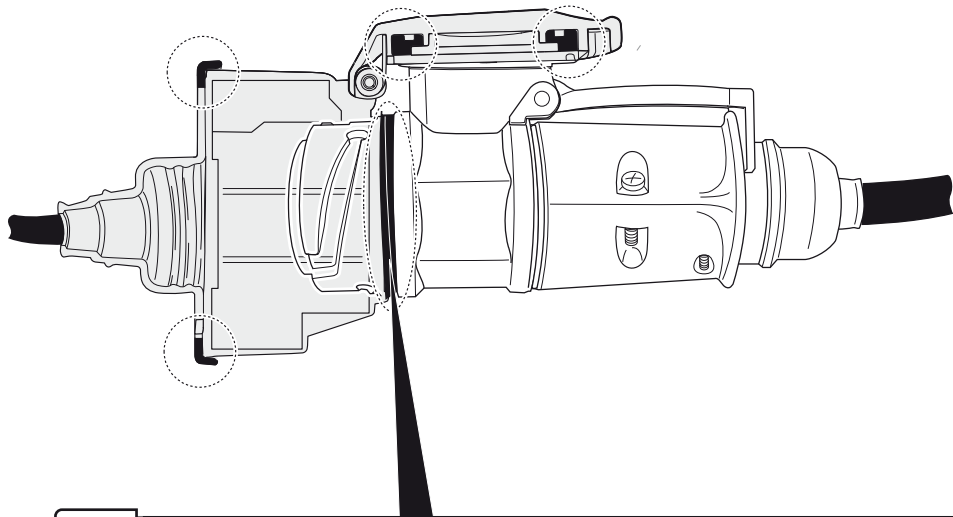
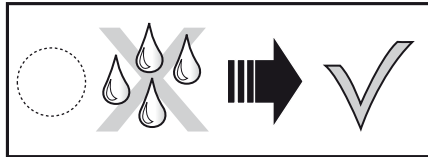
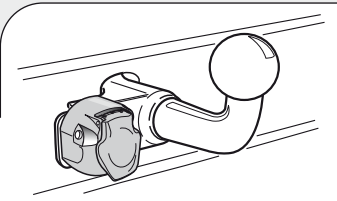
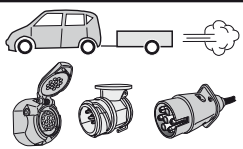

INFO

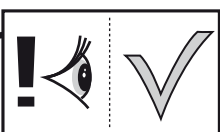
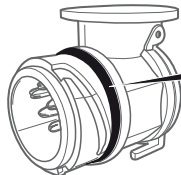
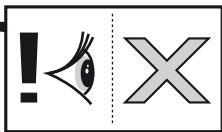
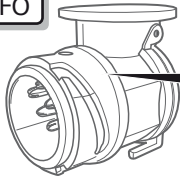

INFO

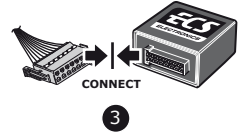
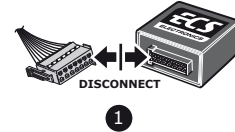

# CHANGING THE FUSE

Corsa E 2015-

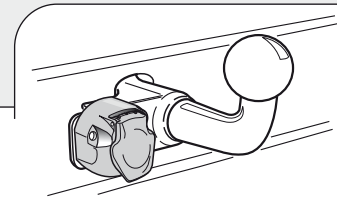
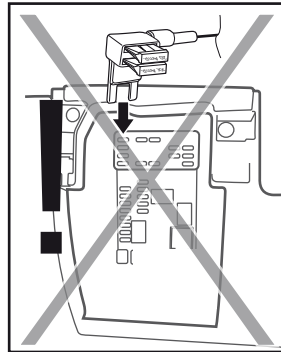
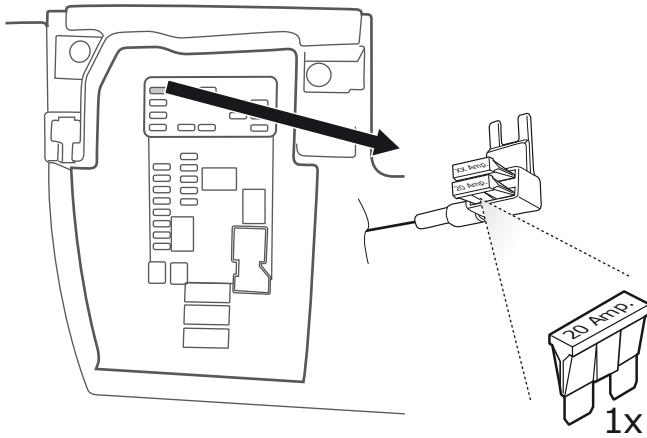
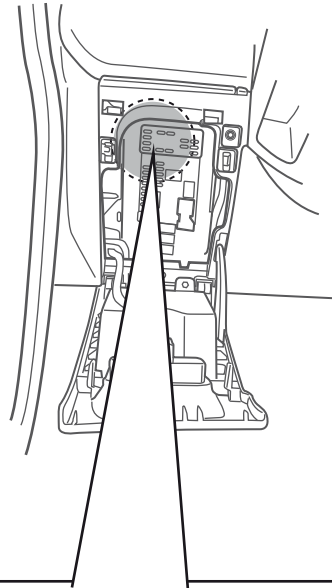
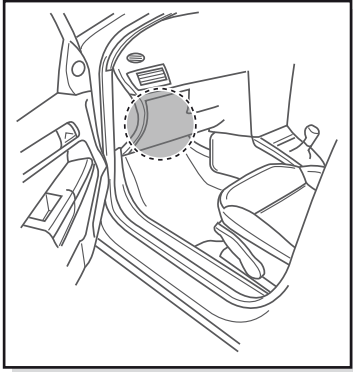

INFO : Storage

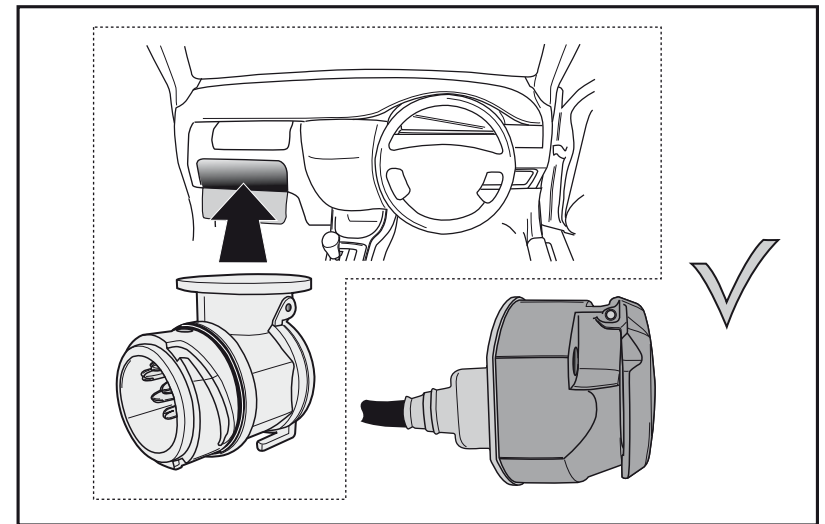
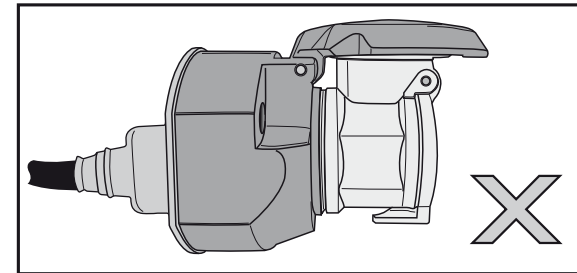
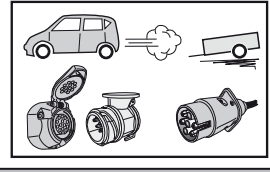

## SOCKET CONNECTION

DIN/ISO 11446			1-8								—		9
	1/L	2	3/31	4/R	5/58-R	6/54	7/58-L	8	9	10	11	12	13
Pmax	21W	21W		21W	42W	3x21W	42W	21W	180W/15Amp	180W/15Amp			
Colour	Yellow	Blue	White	Green	Brown	Red 1,00 mm <sup>2</sup>	Black	Black/ Red	Brown/ White	Red 2,50 mm <sup>2</sup>	White	-	White



In a coupled trailer with working fog lamp, the fog lamp of the vehicle will be switched off, if applicable.

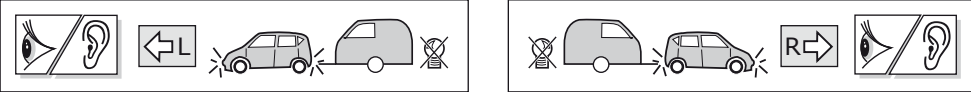

7-pole wiring-harness kit with a C2 telltale.  
A defective indicator light of the car or/and caravan/trailer is stated by a quicker flashing of the other indicator light (Following the European directive 76/756/EEC § 4.5 and StVZO § 54). The functioning of the C2- telltale can be tested by connecting the trailer/caravan (or a test-box) and switching on the indicator lights with a removed indicator light. The other indicator lights will flash quicker. (ATTENTION: a test-box on which only LED's are being used, can not be used in this case).

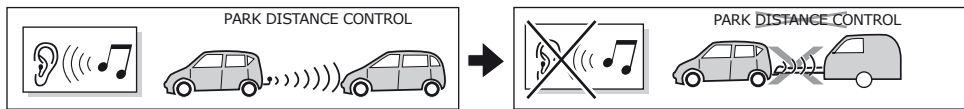

The wiring kit has a possibility to switch off any Park Distance Control in the case of a coupled trailer.

## CHANGING THE FUSE

Astra J Hatchback 12/2009-  
Astra J Station Wagon 12/2010-  
Astra Station Wagon 2012-  
Astra Sedan 2012-  
Astra GTC 2011-

