

! INFO !

Do not charge the battery of the towing vehicle and/or towed vehicle directly via the socket.

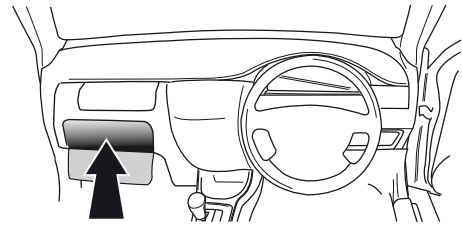

User guide

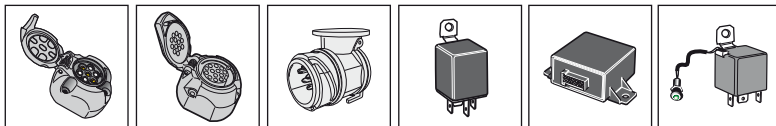

SPARE PARTS

www.ecs-electronicsuk.co.uk



Partnr.: PE-067-D1U

User Guide

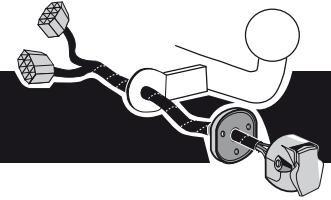

**Peugeot Expert 07/2016-
Peugeot Traveller 07/2016-
Toyota Pro Ace 02/2016-
Toyota Proace Verso 02/2016-
Citroën Dispatch 07/2016-
Citroën Space Tourer 07/2016-
Vauxhall Vivaro C 07/2019-
Vauxhall Vivaro Life 07/2019-**

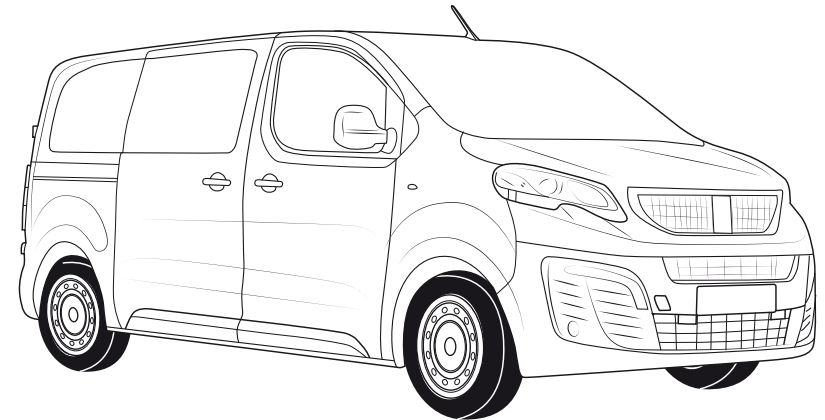

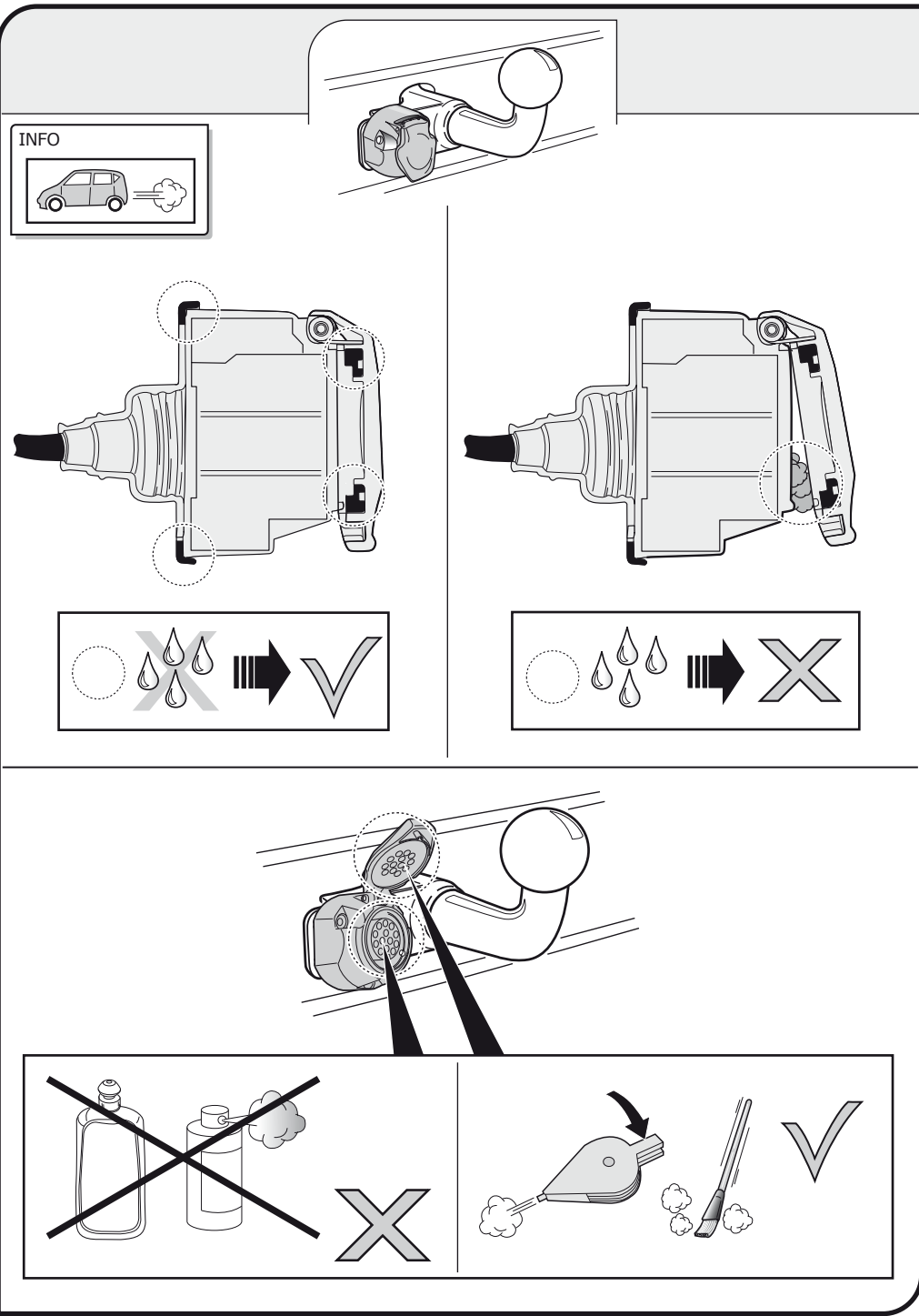

Changing the fuse

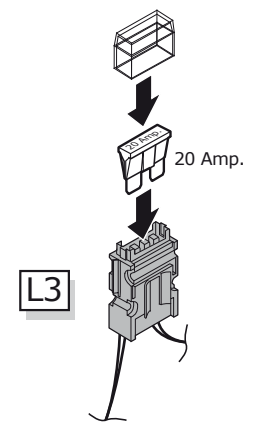

SOCKET CONNECTION

DIN/ISO 11446													
	1/L	2	3/31	4/R	5/58-R	6/54	7/58-L	8	9	10	11	12	13
Pmax	21W	2x21W		21W	52W	3x21W	52W	2x21W	180W/15Amp	180W/15Amp			
Colour	Yellow	Blue	White	Green	Brown	Red 1,00 mm ²	Black	Black/ Red	Brown/ White	Red 2,50 mm ²	White	-	White



In a coupled trailer with working fog lamp, the fog lamp of the vehicle will be switched off, if applicable.

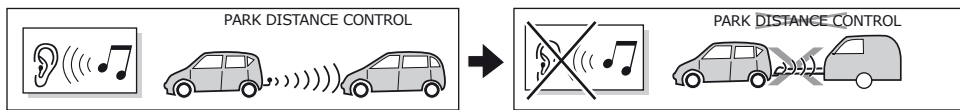

The wiring kit has a possibility to switch off any Park Distance Control in the case of a coupled trailer.

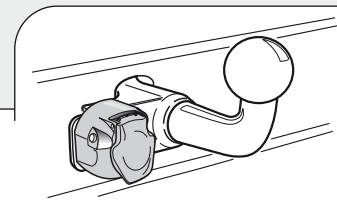

INFO : Ring.

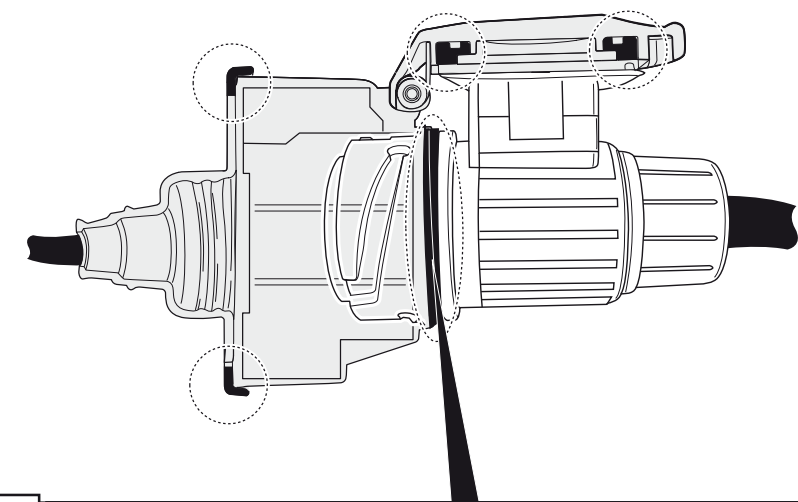
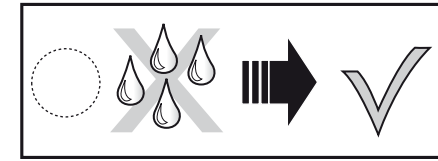
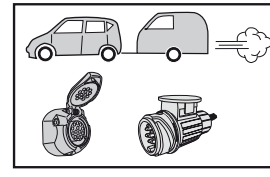

INFO

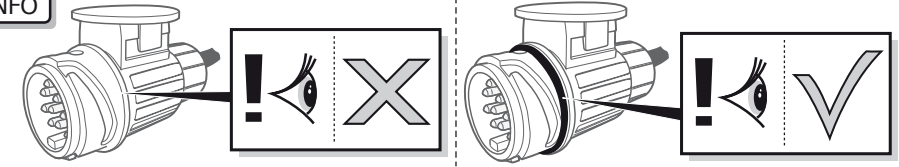

INFO : Adapt.

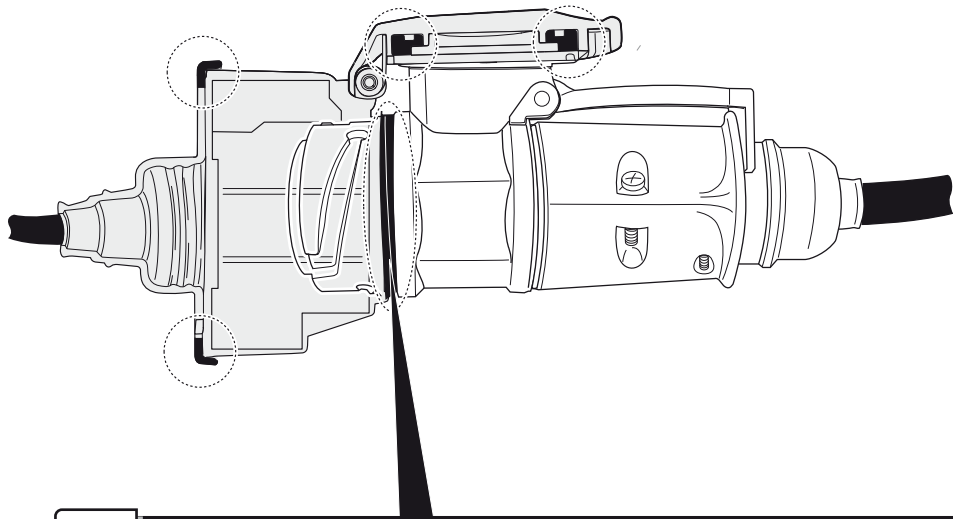
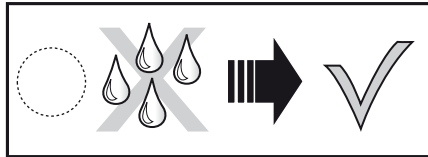
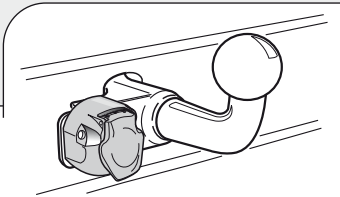
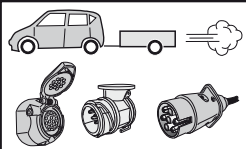

INFO

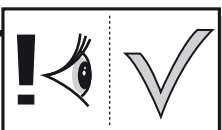
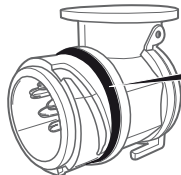
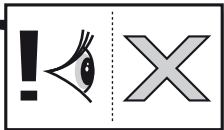
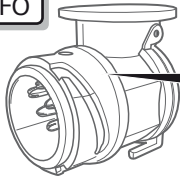

INFO : Storage

